

PMAFIX IP66, IP68 (IP69)

General technical details

PMAFIX connectors. The designation PMAFIX describes a very large range of connectors for PMA conduits with the patented PMA safety clip system.

Connectors are available for ingress protection IP66 and IP68. IP66 connectors are fitted with a pre-installed universal safety clip which ensures a quick “push-in” installation. IP68 connectors for increased requirements will be delivered with a special conduit seal cap. The new PMAFIX IP68GT fittings combine simplest push-in assembly with highest sealing performance. It is also possible to upgrade to IP69 by retrofitting water impact protection.

Material

- Fittings made from specially formulated polyamide 6
- Threads made from nickel-plated brass or polyamide 6
- Self-extinguishing
- Free from halogens, REACH + RoHS compliant
- Very good chemical properties
- Temperature range: -40°C to $+105^{\circ}\text{C}$, short-term to $+160^{\circ}\text{C}$

Characteristics

- Excellent conduit pull-out strength
- High impact resistance
- Vibration-proof connection to PMA corrugated conduits
- Fits conduit profiles – fine (T) and coarse (G)
- To avoid accidental opening, disassembly is only possible with a screwdriver





PMAFIX

General technical details



—
Patent



—
Patent



—
Patent

IP66

IP66 static

IP54 dynamic

- One piece fitting
- Conical sealing method
- Easy “push-in” installation
- Pre-installed safety clip AFN2
- Content of delivery: Connector with pre-installed safety clip

IP68GT

IP68 static

IP67 dynamic

IP69 according to IEC 60529

- The single piece PMAFIX IP68GT fitting with integrated sealing cap and pre-installed locking clip
- Simple push-in assembly (as with the proven PMAFIX IP66 system)
- The extra long sealing cap guarantees the highest level of ingress protection
- Identical approvals as for the PMAFIX IP68 system component version
- Fast modification of specification drawings through simple addition of ,GT' to the existing order number (e.g. BVNV-M257 → BVNV-M257GT)
- Additional water protection ring WPS for IP69 ingress protection in conjunction with the IP68 system to be applied right after the IP68 connector onto the conduit
- Content of delivery: Connector with integrated sealing cap, pre-installed safety clip and thread seal for male thread (O-ring and/or flat gasket)

IP68

IP68 static

IP67 dynamic

IP69 according to IEC 60529

- High sealing through additional seal cap
- For highest dynamic applications
- Additional water protection ring WPS for IP69 ingress protection in conjunction with the IP68 system to be applied right after the IP68 connector onto the conduit
- Content of delivery: Connector with sealing cap, safety clip and thread seal for male thread (O-ring and/or flat gasket)

PMAFIX

Part number codes

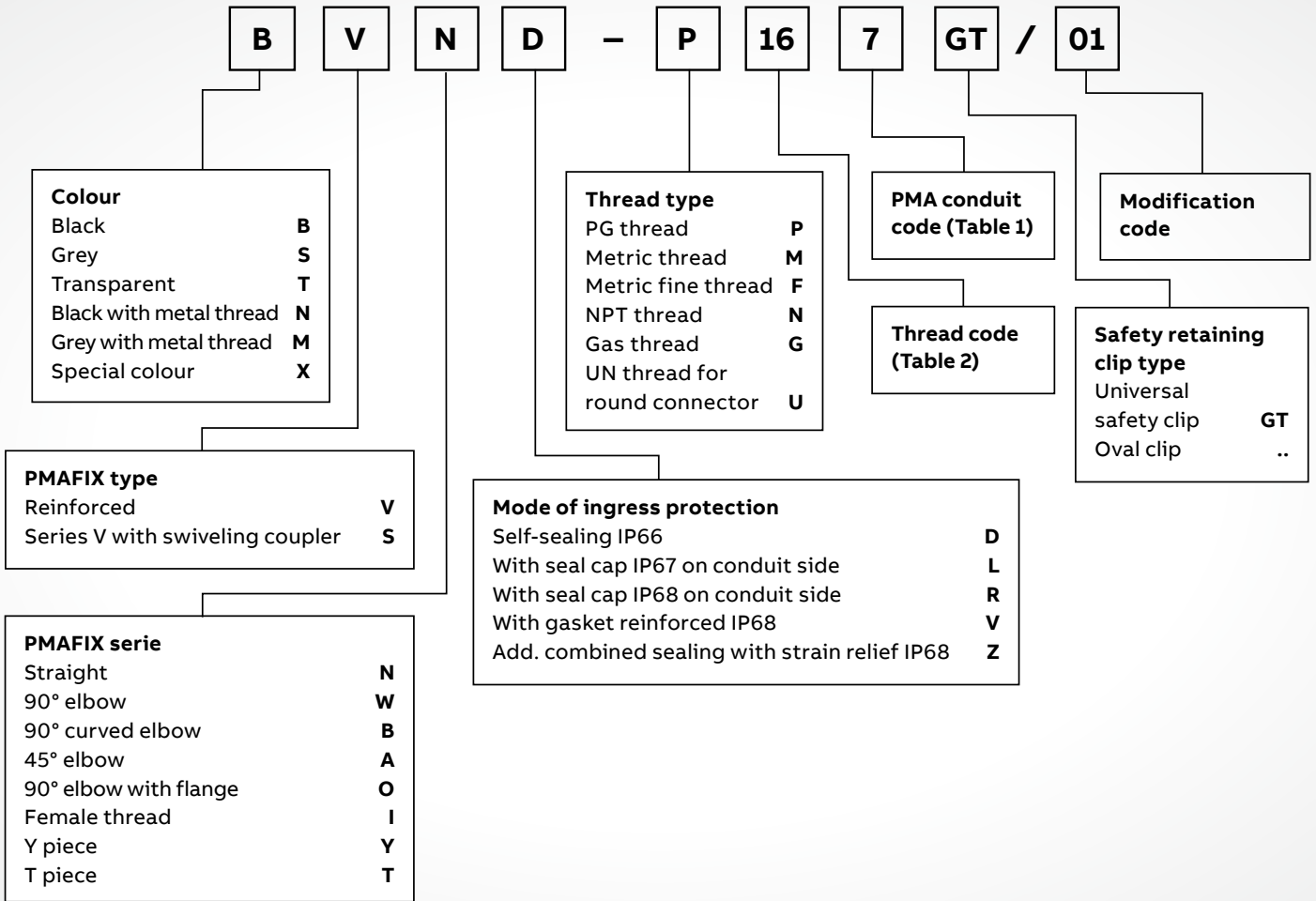

Connector series

- 01 Serie N
- 02 Serie W
- 03 Serie B
- 04 Serie A
- 05 Serie O
- 06 Serie I
- 07 Serie Y
- 08 Serie T

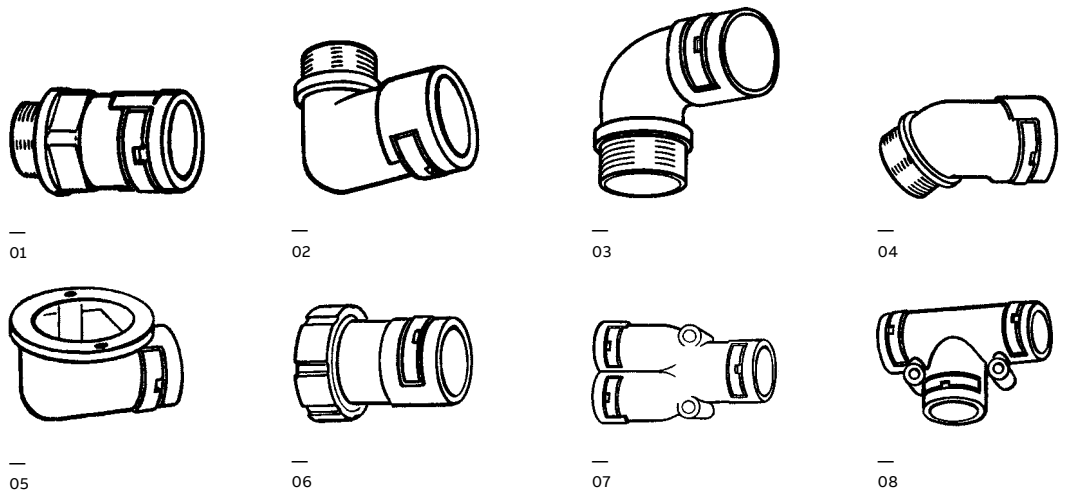

PMAFIX

Size codes

Table 1: Conduit codes

Nominal width	Metric size	PMA code
07	10	M
10	12	0
12	16	2
17	20	7
23	25	3
29	32	9
36	40	6
48	50	8

Additional code for female thread connectors

Type	PMA code
AMP	A
Souriau (ex Burndy) UTG 6	B
With O-ring groove (MIL C 5015)	G
Souriau UTO/UTS	S

Table 2: Thread codes

Thread metric	PMA code	Thread PG	PMA code	Thread Gas	PMA code	Thread NPT	PMA code	Thread UN	PMA code
		PG07	P07	G ¼	G00				
M12 x 1.5	M12	PG09	P09	G ⅜	G01				
M16 x 1.5	M16	PG11	P11	G ½	G02	N ½	N02	½-28 UNEF	U12
M20 x 1.5	M20	PG13.5	P13	G ¾	G04	N ¾	N04	9/16-24 UNEF	U13
		PG16	P16	G 1	G06	N 1	N06	5/8-24 UNEF	U15
M25 x 1.5	M25	PG21	P21	G 1¼	G07	N 1¼	N07	11/16-24 UNEF	U16
M32 x 1.5	M32	PG29	P29	G 1½	G08	N 1½	N08	¾-20 UNEF	U18
M40 x 1.5	M40	PG36	P36	G 2	G09	N 2	N09	13/16-20 UNEF	U20
M50 x 1.5	M50	PG42	P42	G 2¼	G10			7/8-20 UNEF	U21
M63 x 1.5	M63	PG48	P48	G 2½	G11			15/16-20 UNEF	U23
								1-20 UNEF	U24
								1¼-18 UNEF	U26
M 8 x 1.0	F08							13/16-18 UNEF	U29
M12 x 1.0	F12							1¼-18 UNEF	U30
M18 x 1.0	F18							15/16-18 UNEF	U32
								13/8-18 UNEF	U34
								17/16-18 UNEF	U35
								15/8-18 UNEF	U40
								1¾-18 UNS	U43
								2-18 UNS	U50
								2¼-16 UN	U56
								23/8-12 UN	U57
								2½-12 UN	U62

PMAFIX
Installation

Installation IP66

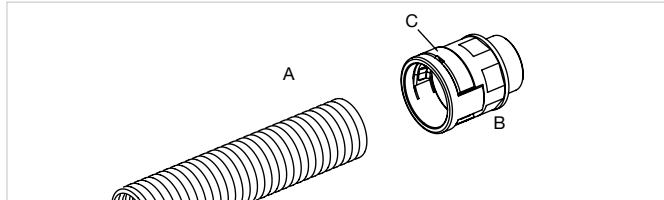

01

A = Conduit
B = Fitting
C = Universal safety clip

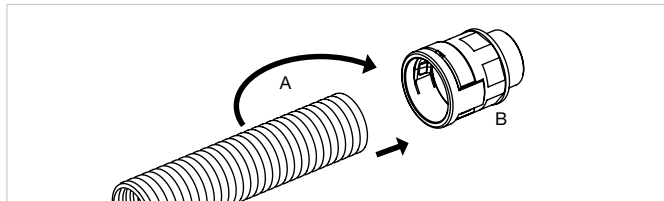

02

Push in the conduit (A) with a slight twist until the stop.

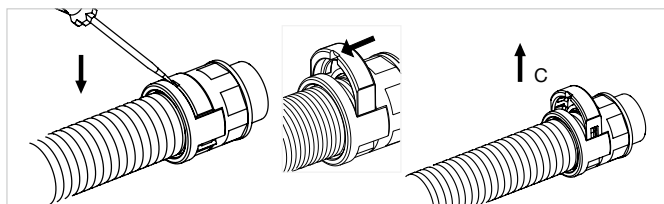

03

To re-open use a screwdriver.
The screwdriver slot in the oval clip (C) should be on the conduit side.

Locking clip pre-installed in all IP66 connectors.

Installation IP68GT

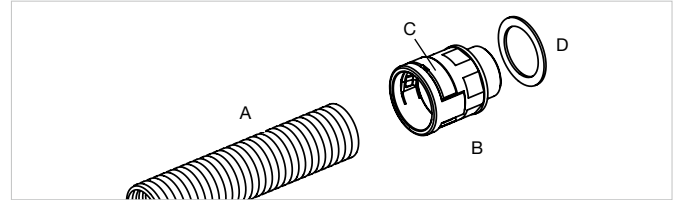

01

A = Conduit
B = Fitting with integrated sealing cap
C = Universal safety clip
D = Thread seal (either O-ring or flat gasket*, not both)

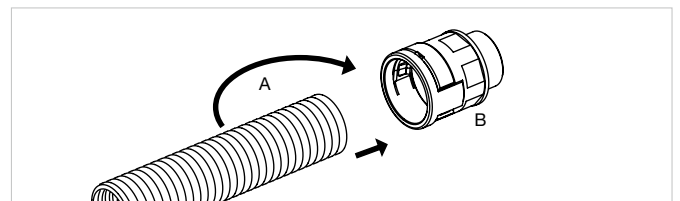

02

Push in the conduit (A) right into the end of the fitting (B) with a slight twist. Additional insertion resistance will be felt when the end of the fitting has been reached.

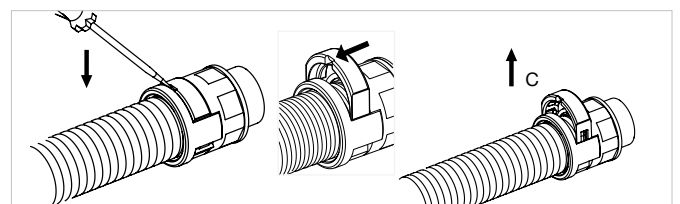

03

To re-open use a screwdriver.
The screwdriver slot in the oval clip (C) should be on the conduit side.

Pre-installed sealing cap and locking clip in all IP68GT connectors.

* Ensure to follow O-ring manufacturers guidelines when using O-rings for sealing purposes.

PMAFIX

Installation

Installation IP68 (IP69)

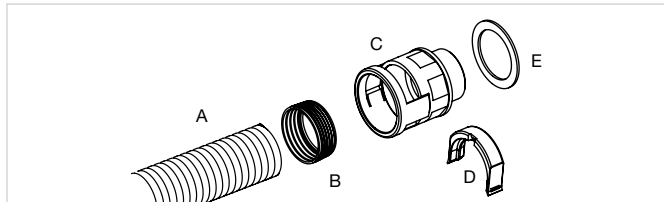

01

- A = Conduit
- B = Sealing cap
- C = Fitting
- D = Oval clip
- E = Thread seal (O-ring or flat seal*)

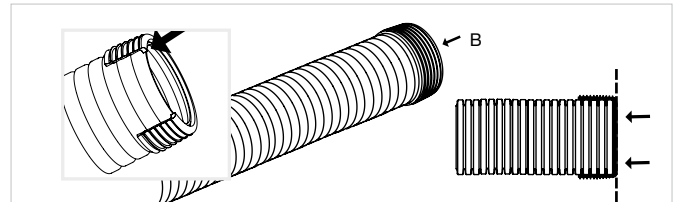

02

Push sealing cap (B) completely onto the conduit in order to achieve IP68.

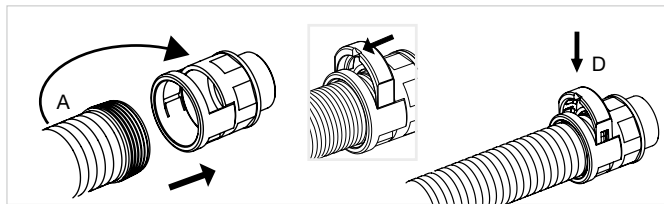

03

Push in the conduit (A) with a slight twist until the stop. Insert oval clip (D) in the locking element window and click into place. Screwdriver slot in the oval clip should be on conduit side.

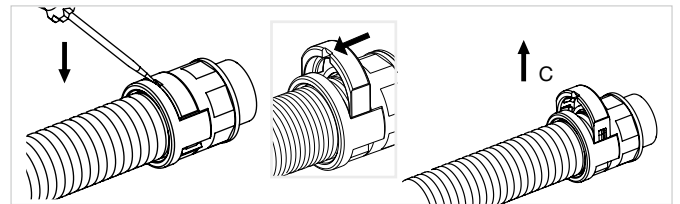

04

To re-open use a screwdriver.

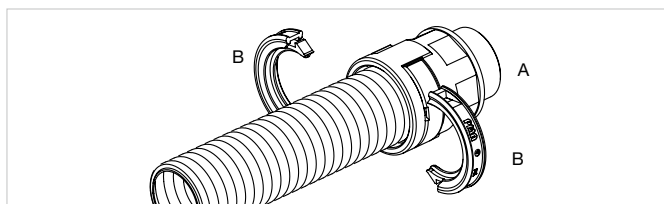

05

- For IP69:
- Based on IP68 System
- A = Conduit with IP68 fitting
- B = WPS half shells

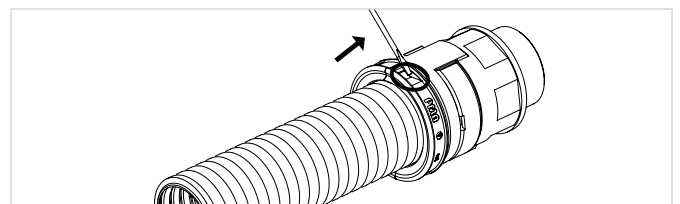

06

To re-open use a screwdriver.

* For safety reasons, oval clip will not fit if seal cap is not fully installed.

Ensure to follow O-ring manufacturers guidelines when using O-rings for sealing purposes.

PMAFIX

Connectors metric, polyamide thread

Installation IP66

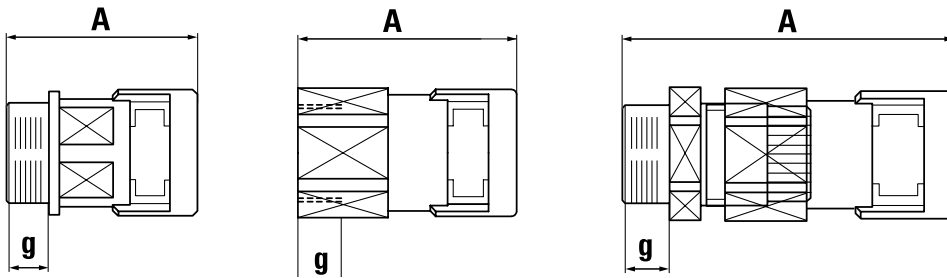

g = Thread length
A = Overall length

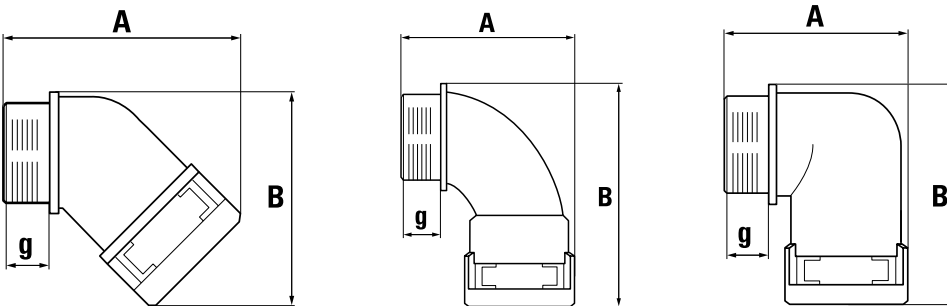

g = Thread length
A x B = External dimensions

Type VN - Connector straight, metric thread

	Order no. IP66 ①	Order no. IP68* ① ②	Thread metric	Fits to conduit size		Thread length (mm)	Overall length (mm)
				NW	Metric		
	BVND-M12MGT	BVNV-M12M	M12 x 1.5	07	10	11.0	34.5
	BVND-M120GT	BVNV-M120	M12 x 1.5	10	12	11.0	36.5
	BVND-M160GT	BVNV-M160	M16 x 1.5	10	12	11.0	36.5
	BVND-M162GT	BVNV-M162	M16 x 1.5	12	16	11.0	39.5
	BVND-M200GT	BVNV-M200	M20 x 1.5	10	12	11.0	36.5
	BVND-M202GT	BVNV-M202	M20 x 1.5	12	16	11.0	39.5
	BVND-M207GT	BVNV-M207	M20 x 1.5	17	20	11.0	47.5
	BVND-M203GT	BVNV-M203	M20 x 1.5	23	25	11.0	51.0
	BVND-M257GT	BVNV-M257	M25 x 1.5	17	20	12.0	48.5
	BVND-M253GT	BVNV-M253	M25 x 1.5	23	25	12.0	52.0
	BVND-M323GT	BVNV-M323	M32 x 1.5	23	25	15.0	55.5
	BVND-M329GT	BVNV-M329	M32 x 1.5	29	32	15.0	56.0
	BVND-M409GT	BVNV-M409	M40 x 1.5	29	32	19.0	60.0
	BVND-M406GT	BVNV-M406	M40 x 1.5	36	40	19.0	72.5
	BVND-M506GT	BVNV-M506	M50 x 1.5	36	40	19.0	72.0
	BVND-M508GT	BVNV-M508	M50 x 1.5	48	50	19.0	72.5
	BVND-M638GT	BVNV-M638	M63 x 1.5	48	50	19.0	72.0

Approvals



For cable protection systems in a wide range of applications

- ① Please replace "B" for black with "S" for grey in front of the order no.
- ② IP68GT available. Please add "GT" after the order no.

Connectors metric, polyamide thread

Type VNDZ/VNZ & VA

Type VNDZ/VNZ - Connector straight with strain relief, metric thread

	Order no. IP66 ①	Order no. IP68 ① ③	Thread metric	Fits to conduit size		Terminal range	Thread length (mm)	Overall length (mm)
				NW	Metric			
VNDZ/VNZ	BVNDZ-M160GT	–	M16 x 1.5	10	12	5.0–10.0	8.0	62.0
	BVNDZ-M162GT	BVNZ-M162S	M16 x 1.5	12	16	5.0–10.0	8.0	62.0
	BVNDZ-M207GT	BVNZ-M207S	M20 x 1.5	17	20	10.0–14.0	8.0	72.0
	BVNDZ-M253GT	BVNZ-M253S	M25 x 1.5	23	25	13.0–18.0	8.0	81.0
	BVNDZ-M329GT	BVNZ-M329S	M32 x 1.5	29	32	18.0–25.0	10.0	85.0
	BVNDZ-M406GT	BVNZ-M406S	M40 x 1.5	36	40	22.0–32.0	10.0	108.5
	BVNDZ-M508GT	BVNZ-M508S	M50 x 1.5	48	50	30.0–38.0	12.0	119.5
	BVNDZ-M638GT	BVNZ-M638S	M63 x 1.5	48	50	34.0–44.0	12.0	119.5



For machine and plant construction
 For separation of damp and dry areas
 Integrated strain relief optimally holds and seals cables
 If several conductors are used with the connector multiple sealing inserts should be considered
Note: For several conductors multiple sealing inserts MDE are available

Type VA - Connector 45° elbow, metric thread

	Order no. IP66 ①	Order no. IP68 ① ②	Thread metric	Fits to conduit size		Thread length (mm)	Overall length (mm)
				NW	Metric		
VA	BVAD-M120GT	–	M12 x 1.5	10	12	11.0	43.5 x 37.0
	BVAD-M160GT	BVAV-M160	M16 x 1.5	10	12	11.0	43.5 x 38.0
	BVAD-M162GT	BVAV-M162	M16 x 1.5	12	16	11.0	48.0 x 40.0
	BVAD-M202GT	BVAV-M202	M20 x 1.5	12	16	11.0	48.0 x 41.5
	BVAD-M207GT	BVAV-M207	M20 x 1.5	17	20	11.0	55.5 x 51.5
	BVAD-M253GT	BVAV-M253	M25 x 1.5	23	25	12.0	65.0 x 58.5
	BVAD-M329GT	BVAV-M329	M32 x 1.5	29	32	15.0	73.5 x 66.5
	BVAD-M406GT	BVAV-M406	M40 x 1.5	36	40	19.0	92.5 x 85.5
	BVAD-M506GT	BVAV-M506	M50 x 1.5	36	40	19.0	92.5 x 89.5
	BVAD-M508GT	BVAV-M508	M50 x 1.5	48	50	19.0	100.0 x 96.0
	BVAD-M638GT	BVAV-M638	M63 x 1.5	48	50	19.0	100.0 x 104.0

Approvals



- ① Please replace "B" for black with "S" for grey in front of the order no.
- ② IP68GT available. Please add "GT" after the order no.
- ③ IP68GT available. Please replace "S" at the end with "GT" (e.g. BVNZ-M207GT)

Connectors metric, polyamide thread

Type VB & VW

Type VB - Connector 90° curved elbow, metric thread

	Order no. IP66 ①	Order no. IP68 ① ②	Thread metric	Fits to conduit size		Thread length (mm)	External dimensions (mm)
				NW	Metric		
	BVBD-M207GT	BVBV-M207	M20 x 1.5	17	20	11.0	47.5 x 73.0
	BVBD-M257GT	BVBV-M257	M25 x 1.5	17	20	12.0	48.5 x 76.0
	BVBD-M253GT	BVBV-M253	M25 x 1.5	23	25	12.0	57.5 x 83.0
	BVBD-M323GT	BVBV-M323	M32 x 1.5	23	25	15.0	61.0 x 87.5
	BVBD-M329GT	BVBV-M329	M32 x 1.5	29	32	15.0	70.5 x 93.0
	BVBD-M409GT	BVBV-M409	M40 x 1.5	29	32	19.0	74.5 x 98.5
	BVBD-M406GT	BVBV-M406	M40 x 1.5	36	40	19.0	85.0 x 121.0
	BVBD-M506GT	BVBV-M506	M50 x 1.5	36	40	19.0	85.0 x 125.0
	BVBD-M508GT	BVBV-M508	M50 x 1.5	48	50	19.0	98.5 x 130.0
	BVBD-M638GT	BVBV-M638	M63 x 1.5	48	50	19.0	98.5 x 138.0

Approvals



For cable protection systems in a wide range of applications
Smooth elbow allows easy threading of wires and cables

Note: For smaller conduit sizes NW 10 to NW 12 appropriate standard elbows of type VW are also available

Type VW - Connector 90° elbow, metric thread

	Order no. IP66 ①	Order no. IP68 ① ②	Thread metric	Fits to conduit size		Thread length (mm)	External dimensions (mm)
				NW	Metric		
	BVWD-M12MGT	BVWV-M12M	M12 x 1.5	07	10	11.0	32.0 x 35.0
	BVWD-M120GT	BVWV-M120	M12 x 1.5	10	12	11.0	34.0 x 39.5
	BVWD-M160GT	BVWV-M160	M16 x 1.5	10	12	11.0	34.0 x 40.5
	BVWD-M162GT	BVWV-M162	M16 x 1.5	12	16	11.0	38.5 x 46.0
	BVWD-M200GT	-	M20 x 1.5	10	12	11.0	34.0 x 42.5
	BVWD-M202GT	BVWV-M202	M20 x 1.5	12	16	11.0	38.5 x 47.5
	BVWD-M207GT	BVWV-M207	M20 x 1.5	17	20	11.0	43.5 x 58.5
	BVWD-M253GT	BVWV-M253	M25 x 1.5	23	25	12.0	54.0 x 65.0
	BVWD-M329GT	BVWV-M329	M32 x 1.5	29	32	15.0	64.5 x 73.0
	BVWD-M406GT	BVWV-M406	M40 x 1.5	36	40	19.0	78.0 x 96.0
	BVWD-M508GT	BVWV-M508	M50 x 1.5	48	50	19.0	91.5 x 106.0

Approvals



For cable protection systems in a wide range of applications

Note: For sizes NW 17 to NW 48 curved elbows of type VB are also available

- ① Please replace "B" for black with "S" for grey in front of the order no.
- ② IP68GT available. Please add "GT" after the order no.

Connectors metric, metal thread

Type VNV

Type VNV - Connector straight, NPT metal thread

	Order no. IP68, black ⁴	Order no. IP68, grey ⁴	Thread metric	Fits to conduit size		Thread length (mm)	Overall length (mm)
				NW	Metric		
	NVNV-M120-10	MVNV-M120-10	M12 x 1.5	10	12	10.0	40.0
	NVNV-M120-5	MVNV-M120-5	M12 x 1.5	10	12	5.0	35.0
	NVNV-M160-10	MVNV-M160-10	M16 x 1.5	10	12	10.0	40.0
	NVNV-M160-5	MVNV-M160-5	M16 x 1.5	10	12	5.0	35.0
	NVNV-M162-10	MVNV-M162-10	M16 x 1.5	12	16	10.0	43.0
	NVNV-M162-5	MVNV-M162-5	M16 x 1.5	12	16	5.0	38.0
	NVNV-M202-10	MVNV-M202-10	M20 x 1.5	12	16	10.0	43.0
	NVNV-M202-6	MVNV-M202-6	M20 x 1.5	12	16	6.0	39.0
	NVNV-M207-10	MVNV-M207-10	M20 x 1.5	17	20	10.0	51.0
	NVNV-M207-6	MVNV-M207-6	M20 x 1.5	17	20	6.0	47.0
	NVNV-M257-11	MVNV-M257-11	M25 x 1.5	17	20	11.0	52.0
	NVNV-M257-7	MVNV-M257-7	M25 x 1.5	17	20	7.0	48.0
	NVNV-M253-11	MVNV-M253-11	M25 x 1.5	23	25	11.0	54.0
	NVNV-M253-7	MVNV-M253-7	M25 x 1.5	23	25	7.0	50.0
	NVNV-M323-13	MVNV-M323-13	M32 x 1.5	23	25	13.0	56.0
	NVNV-M323-8	MVNV-M323-8	M32 x 1.5	23	25	8.0	51.0
	NVNV-M329-13	MVNV-M329-13	M32 x 1.5	29	32	13.0	57.3
	NVNV-M329-8	MVNV-M329-8	M32 x 1.5	29	32	8.0	52.3
	NVNV-M409-13	MVNV-M409-13	M40 x 1.5	29	32	13.0	57.3
	NVNV-M409-8	MVNV-M409-8	M40 x 1.5	29	32	8.0	52.3
	NVNV-M406-13	MVNV-M406-13	M40 x 1.5	36	40	13.0	71.4
	NVNV-M406-8	MVNV-M406-8	M40 x 1.5	36	40	8.0	66.4
	NVNV-M506-14	MVNV-M506-14	M50 x 1.5	36	40	14.0	72.4
	NVNV-M506-9	MVNV-M506-9	M50 x 1.5	36	40	9.0	67.4
	NVNV-M508-14	MVNV-M508-14	M50 x 1.5	48	50	14.0	72.4
	NVNV-M508-9	MVNV-M508-9	M50 x 1.5	48	50	9.0	67.4
	NVNV-M638-14	MVNV-M638-14	M63 x 1.5	48	50	14.0	72.4
	NVNV-M638-10	MVNV-M638-10	M63 x 1.5	48	50	10.0	68.4

Approvals



For applications in railway vehicles and heavy machine construction
High thread and system connection strength

⁴ IP68GT available. Please add
"GT" prior to the thread length
(for example NVNV-M120GT-10)

Connectors NPT, metal thread

Type VNV

Type VNV - Connector straight, metric metal thread

	Order no. IP68, black ⁴	Thread NPT	Fits to conduit size		Thread length (mm)	Overall length (mm)
			NW	Metric		
	NVNV-N022	½"	12	16	15.4	48.1
	NVNV-N027	½"	17	20	15.4	56.4
	NVNV-N043	¾"	23	25	15.7	58.7
	NVNV-N069	1"	29	32	19.6	63.9
	NVNV-N076	1¼"	36	40	20.2	78.6
	NVNV-N088	1½"	48	50	20.6	79.0
	NVNV-N098	2"	48	50	21.4	79.8

Approvals



For applications in railway vehicles and heavy machine construction
High thread and system connection strength

⁴ IP68GT available. Please add
"GT" prior to the thread length
(for example NVNV-N022GT)

Connectors with strain relief, metric, metal thread

Type VNZ

Type VNZ - Connector straight with strain relief, metric metal thread



	Order no. IP68 Compl., black ⑤	Order no. fitting* ⑤	Order no. insert	Thread metric	Fits to conduit size		Terminal range (mm)	Thread length (mm)	Overall length (mm)
					NW	Metric			
	NVNZ-M120S/P1	NVNZ-M120R/P	EK 150p7	M12 x 1.5	10	12	4.0–6.5	5.0	48.5
	NVNZ-M120S/P2		EK 150p8	M12 x 1.5	10	12	5.0–8.0	5.0	48.5
	NVNZ-M120S/P3		EK 150p9	M12 x 1.5	10	12	6.5–9.5	5.0	48.5
	NVNZ-M160S/P1	NVNZ-M160R/P	E 150p7	M16 x 1.5	10	12	4.0–6.5	6.0	49.5
	NVNZ-M160S/P2		E 150p8	M16 x 1.5	10	12	5.0–8.0	6.0	49.5
	NVNZ-M160S/P3		E 150p9	M16 x 1.5	10	12	6.5–9.5	6.0	49.5
	NVNZ-M202S/P1	NVNZ-M202R/P	E 152p7	M20 x 1.5	12	16	4.0–6.5	6.0	54.0
	NVNZ-M202S/P3		E 152p9	M20 x 1.5	12	16	6.5–9.5	6.0	54.0
	NVNZ-M202S/P4		E 152p11	M20 x 1.5	12	16	7.0–10.5	6.0	54.0
	NVNZ-M207S/P3	NVNZ-M207R/P	E 152p9	M20 x 1.5	17	20	6.5–9.5	6.5	60.0
	NVNZ-M207S/P4		E 152p11	M20 x 1.5	17	20	7.0–10.5	6.5	60.0
	NVNZ-M207S/P5		E 152p13	M20 x 1.5	17	20	9.0–13.0	6.5	60.0
	NVNZ-M253S/P5	NVNZ-M253R/P	EK 154p13	M25 x 1.5	23	25	9.0–13.0	7.5	72.5
	NVNZ-M253S/P6		EK 154p16	M25 x 1.5	23	25	11.5–15.5	7.5	72.5
	NVNZ-M257S/P4	NVNZ-M257R/P	E 153p11	M25 x 1.5	17	20	7.0–10.5	7.5	61.5
	NVNZ-M257S/P5		E 153p13	M25 x 1.5	17	20	9.0–13.0	7.5	61.5
	NVNZ-M257S/P6		E 153p16	M25 x 1.5	17	20	11.5–15.5	7.5	61.5
	NVNZ-M323S/P4	NVNZ-M323R/P	E 154p18	M32 x 1.5	23	25	14.0–18.0	8.0	73.0
	NVNZ-M323S/P5	NVNZ-M323R1/P	E 154p20	M32 x 1.5	23	25	17.0–20.5	8.0	73.0
	NVNZ-M329S/P2	NVNZ-M329R/P	EK 155p18	M32 x 1.5	29	32	14.0–18.0	8.0	73.0
	NVNZ-M329S/P3		EK 155p20	M32 x 1.5	29	32	17.0–20.5	8.0	73.0
	NVNZ-M329S/P4		EK 155p25	M32 x 1.5	29	32	20.0–25.0	8.0	73.0
	NVNZ-M406S/P1	NVNZ-M406R/P	E 156p25HF	M40 x 1.5	36	40	20.0–25.0	9.0	87.0
	NVNZ-M406S/P2		EK 156p28	M40 x 1.5	36	40	24.0–28.0	9.0	87.0
	NVNZ-M409S/P1	NVNZ-M409R/P	E 155p16	M40 x 1.5	29	32	11.5–15.5	8.0	73.0
	NVNZ-M409S/P2		E 155p18	M40 x 1.5	29	32	14.0–18.0	8.0	73.0
	NVNZ-M409S/P3		E 155p20	M40 x 1.5	29	32	17.0–20.5	8.0	73.0
	NVNZ-M409S/P4		E 155p25	M40 x 1.5	29	32	20.0–25.0	8.0	73.0
	NVNZ-M409S/P5		E 155p28	M40 x 1.5	29	32	24.0–28.0	8.0	73.0
	NVNZ-M506S/P1	NVNZ-M506R/P	E 156p32	M50 x 1.5	36	40	27.0–32.0	9.0	89.5
	NVNZ-M506S/P3		E 156p36	M50 x 1.5	36	40	32.0–36.0	9.0	89.5
	NVNZ-M508S/P2	NVNZ-M508R/P	E 157p36HF	M50 x 1.5	48	50	32.0–36.0	9.0	92.0
NVNZ-M508S/P3		E 157p40HF	M50 x 1.5	48	50	36.0–40.0	9.0	92.0	
NVNZ-M638S/P1	NVNZ-M638R/P	E 158pm1x35	M63 x 1.5	48	50	32.0–35.0	10.0	90.5	
NVNZ-M638S/P2		E 158p44	M63 x 1.5	48	50	39.0–44.0	10.0	90.5	

*without insert

For applications in railway vehicles and heavy machine construction

For the separation of damp and dry areas

Sealing inserts are made from TPE-V

With integrated strain relief and optimal ingress protection at the cable (up to IP68/10 bar)

High thread and system connection strength

Temperature range sealing insert Pflitsch: –40°C to +135°C

Note: For several conductors multiple sealing inserts MDE are available. R/P version of fitting has to be used in combination with multiple sealing inserts

⑤ IP68GT available. Please replace "S" or "R" with "GT" (e.g. NVNZ-M120GT/P1, NVNZ-M120GT/P)

Fire barrier connectors with strain relief, metric, metal thread

Type VNZ

Type VNZ - Fire barrier connector straight with strain relief, metric metal thread



	Order no. IP68 Compl., black ⁵	Thread metric	Fits to conduit size		Terminal range (mm)	Thread length (mm)	Overall length (mm)
			NW	Metric			
	NVNZ-M120S/B1	M12 x 1.5	10	12	4.0–6.5	5.0	48.5
	NVNZ-M120S/B2	M12 x 1.5	10	12	5.0–8.0	5.0	48.5
	NVNZ-M120S/B3	M12 x 1.5	10	12	6.5–9.5	5.0	48.5
	NVNZ-M160S/B1	M16 x 1.5	10	12	4.0–6.5	6.0	49.5
	NVNZ-M160S/B2	M16 x 1.5	10	12	5.0–8.0	6.0	49.5
	NVNZ-M160S/B3	M16 x 1.5	10	12	6.5–9.5	6.0	49.5
	NVNZ-M202S/B1	M20 x 1.5	12	16	4.0–6.5	6.0	54.0
	NVNZ-M202S/B3	M20 x 1.5	12	16	6.5–9.5	6.0	54.0
	NVNZ-M202S/B4	M20 x 1.5	12	16	7.0–10.5	6.0	54.0
	NVNZ-M207S/B1	M20 x 1.5	17	20	4.0–6.5	6.5	60.0
	NVNZ-M207S/B2	M20 x 1.5	17	20	5.0–8.0	6.5	60.0
	NVNZ-M207S/B3	M20 x 1.5	17	20	6.5–9.5	6.5	60.0
	NVNZ-M207S/B4	M20 x 1.5	17	20	7.0–10.5	6.5	60.0
	NVNZ-M207S/B5	M20 x 1.5	17	20	9.0–13.0	6.5	60.0
	NVNZ-M253S/B5	M25 x 1.5	23	25	9.0–13.0	7.5	72.5
	NVNZ-M253S/B6	M25 x 1.5	23	25	11.5–15.5	7.5	72.5
	NVNZ-M257S/B4	M25 x 1.5	17	20	7.0–10.0	7.5	61.5
	NVNZ-M257S/B5	M25 x 1.5	17	20	9.0–13.0	7.5	61.5
	NVNZ-M257S/B6	M25 x 1.5	17	20	11.5–15.5	7.5	61.5
	NVNZ-M323S/B4	M32 x 1.5	23	25	14.0–18.0	8.0	73.0
	NVNZ-M323S/B5	M32 x 1.5	23	25	17.0–20.5	8.0	73.0
	NVNZ-M329S/B2	M32 x 1.5	29	32	14.0–18.0	8.0	73.0
	NVNZ-M329S/B3	M32 x 1.5	29	32	17.0–20.5	8.0	73.0
	NVNZ-M329S/B4	M32 x 1.5	29	32	20.0–25.0	8.0	73.0
	NVNZ-M406S/B1	M40 x 1.5	36	40	20.0–25.0	9.0	87.0
	NVNZ-M406S/B2	M40 x 1.5	36	40	24.0–28.0	9.0	87.0
	NVNZ-M409S/B1	M40 x 1.5	29	32	11.5–15.5	8.0	73.0
	NVNZ-M409S/B2	M40 x 1.5	29	32	14.0–18.0	8.0	73.0
	NVNZ-M409S/B3	M40 x 1.5	29	32	17.0–20.5	8.0	73.0
	NVNZ-M409S/B4	M40 x 1.5	29	32	20.0–25.0	8.0	73.0
	NVNZ-M409S/B5	M40 x 1.5	29	32	24.0–28.0	8.0	73.0
	NVNZ-M506S/B1	M50 x 1.5	36	40	27.0–32.0	9.0	89.5
	NVNZ-M506S/B3	M50 x 1.5	36	40	32.0–36.0	9.0	89.5
NVNZ-M508S/B2	M50 x 1.5	48	50	32.0–36.0	9.0	92.0	
NVNZ-M508S/B3	M50 x 1.5	48	50	36.0–40.0	9.0	92.0	
NVNZ-M638S/B1	M63 x 1.5	48	50	32.0–35.0	10.0	90.5	
NVNZ-M638S/B2	M63 x 1.5	48	50	39.0–44.0	10.0	90.5	

* without insert

Fire barrier function, according to standard EN45545-2/-3

For applications in railway vehicles and heavy machine construction

For the separation of damp and dry areas

Sealing inserts are made from T80S

With integrated strain relief and optimal ingress protection at the cable (up to IP68/10 bar)

High thread and system connection strength

Temperature range sealing insert Pflitsch: –40°C to +135°C

Note: For several conductors multiple sealing inserts MDE are available.

R/P version of fitting has to be used in combination with multiple sealing inserts

⁵ IP68GT available. Please
replace “S” or “R” with “GT”
(e.g. NVNZ-M120GT/P1,
NVNZ-M120GT/P)

Connectors with strain relief, metric, long metal thread

Type VNZ

Type VNZ - Connector straight with strain relief, metric long metal thread



	Order no. IP68 Compl., black ⑤	Order no. fitting* ⑤	Order no. insert	Thread metric	Fits to conduit size		Terminal range (mm)	Thread length (mm)	Overall length (mm)
					NW	Metric			
	NVNZ-M120S/P1-L	NVNZ-M120R/P-L	EK 150p7	M12 x 1.5	10	12	4.0–6.5	15.0	66.5
	NVNZ-M120S/P3-L			M12 x 1.5	10	12	6.5–9.5	15.0	66.5
	NVNZ-M160S/P1-L	NVNZ-M160R/P-L	E 150p7	M16 x 1.5	10	12	4.0–6.5	15.0	58.5
	NVNZ-M160S/P2-L		E 150p8	M16 x 1.5	10	12	5.0–8.0	15.0	58.5
	NVNZ-M160S/P3-L		E 150p9	M16 x 1.5	10	12	6.5–9.5	15.0	58.5
	NVNZ-M202S/P1-L	NVNZ-M202R/P-L	E 152p7	M20 x 1.5	12	16	4.0–6.5	15.0	62.5
	NVNZ-M202S/P3-L		E 152p9	M20 x 1.5	12	16	6.5–9.5	15.0	62.5
	NVNZ-M202S/P4-L		E 152p11	M20 x 1.5	12	16	7.0–10.5	15.0	62.5
	NVNZ-M207S/P3-L	NVNZ-M207R/P-L	E 152p9	M20 x 1.5	17	20	6.5–9.5	15.0	68.5
	NVNZ-M207S/P4-L		E 152p11	M20 x 1.5	17	20	7.0–10.5	15.0	68.5
	NVNZ-M207S/P5-L		E 152p13	M20 x 1.5	17	20	9.0–13.0	15.0	68.5
	NVNZ-M257S/P5-L	NVNZ-M257R/P-L	E 153p13	M25 x 1.5	17	20	9.0–13.0	15.0	69.0
	NVNZ-M257S/P6-L		E 153p16	M25 x 1.5	17	20	11.5–15.5	15.0	69.0
	NVNZ-M323S/P4-L	NVNZ-M323R/P-L	E 154p18	M32 x 1.5	23	25	14.0–18.0	15.0	80.0
	NVNZ-M323S/P5-L	NVNZ-M323R1/P-L	E 154p20	M32 x 1.5	23	25	17.0–20.5	15.0	80.0
	NVNZ-M329S/P2-L	NVNZ-M329R/P-L	E 155p18	M32 x 1.5	29	32	14.0–18.0	15.0	91.0
	NVNZ-M329S/P3-L		E 155p20	M32 x 1.5	29	32	17.0–20.5	15.0	91.0
	NVNZ-M409S/P3-L	NVNZ-M409R/P-L	E 155p20	M40 x 1.5	29	32	17.0–20.5	15.0	80.0
	NVNZ-M409S/P4-L		E 155p25	M40 x 1.5	29	32	20.0–25.0	15.0	80.0
	NVNZ-M409S/P5-L		E 155p28	M40 x 1.5	29	32	24.0–28.0	15.0	80.0
	NVNZ-M506S/P1-L	NVNZ-M506R/P-L	E 156p32	M50 x 1.5	36	40	27.0–32.0	15.0	94.5
	NVNZ-M506S/P3-L		E 15p36	M50 x 1.5	36	40	32.0–36.0	15.0	94.5
	NVNZ-M508S/P2-L	NVNZ-M508R/P-L	E 157p36HF	M50 x 1.5	48	50	32.0–36.0	15.0	97.0
	NVNZ-M508S/P3-L		E 157p40HF	M50 x 1.5	48	50	36.0–40.0	15.0	97.0
	NVNZ-M638S/P1-L	NVNZ-M638R/P-L	E 158pm1X35	M63 x 1.5	48	50	32.0–35.0	15.0	95.5
	NVNZ-M638S/P2-L		E 158p44	M63 x 1.5	48	50	39.0–44.0	15.0	95.5

*without insert

For applications in railway vehicles and heavy machine construction

For the separation of damp and dry areas

Sealing inserts are made from TPE-V

With integrated strain relief and optimal ingress protection at the cable (up to IP68/10 bar)

High thread and system connection strength

Temperature range sealing insert Pflitsch: –40°C to +135°C

Note: For several conductors multiple sealing inserts MDE are available

R/P version of fitting has to be used in combination with multiple sealing inserts

⑤ IP68GT available. Please replace “S” or “R” with “GT” (e.g. NVNZ-M120GT/P1-L)

Connectors metric, metal thread

Type VAV

Type VAV - Connector 45° elbow, metric metal thread

	Order no. IP68, black ⁴	Order no. IP68, grey ⁴	Thread metric	Fits to conduit size		Thread length (mm)	External dimensions (mm)
				NW	Metric		
	NVAV-M120-10	MVAV-M120-10	M12 x 1.5	10	12	10.0	48.5 x 37.0
	NVAV-M120-5	MVAV-M120-5	M12 x 1.5	10	12	5.0	43.5 x 37.0
	NVAV-M162-10	MVAV-M162-10	M16 x 1.5	12	16	10.0	53.0 x 40.5
	NVAV-M162-5	MVAV-M162-5	M16 x 1.5	12	16	5.0	48.0 x 40.5
	NVAV-M207-10	MVAV-M207-10	M20 x 1.5	17	20	10.0	60.5 x 51.5
	NVAV-M207-6	MVAV-M207-6	M20 x 1.5	17	20	6.0	56.5 x 51.5
	NVAV-M253-11	MVAV-M253-11	M25 x 1.5	23	25	11.0	70.0 x 60.5
	NVAV-M253-7	MVAV-M253-7	M25 x 1.5	23	25	7.0	66.0 x 60.5
	NVAV-M257-11	MVAV-M257-11	M25 x 1.5	17	20	11.0	61.5 x 54.5
	NVAV-M323-13	MVAV-M323-13	M32 x 1.5	23	25	13.0	72.0 x 64.5
	NVAV-M329-13	MVAV-M329-13	M32 x 1.5	29	32	13.0	77.0 x 68.0
	NVAV-M329-8	MVAV-M329-8	M32 x 1.5	29	32	8.0	72.0 x 68.0
	NVAV-M406-13	MVAV-M406-13	M40 x 1.5	36	40	13.0	94.0 x 87.5
	NVAV-M406-8	MVAV-M406-8	M40 x 1.5	36	40	8.0	89.0 x 87.5
	NVAV-M409-13	MVAV-M409-13	M40 x 1.5	29	32	13.0	77.0 x 73.0
	NVAV-M506-14	MVAV-M506-14	M50 x 1.5	36	40	14.0	95.0 x 92.5
	NVAV-M508-14	MVAV-M508-14	M50 x 1.5	48	50	14.0	102.0 x 101.0
	NVAV-M508-9	MVAV-M508-9	M50 x 1.5	48	50	9.0	97.0 x 101.0
NVAV-M638-14	MVAV-M638-14	M63 x 1.5	48	50	14.0	102.0 x 104.0	
NVAV-M638-10	MVAV-M638-10	M63 x 1.5	48	50	10.0	98.0 x 104.0	

Approvals



For applications in railway vehicles and heavy machine construction
High thread and system connection strength

⁴ IP68GT available. Please add "GT" prior to the thread length (e.g. NVAV-M120GT-10, NVBV-M120GT-10)

Connectors metric, metal thread

Type VBV

Type VBV - Connector 90° curved elbow, metric metal thread

	Order no. IP68, black ⑤	Order no. IP68, grey ⑤	Thread metric	Fits to conduit size		Thread length (mm)	External dimensions (mm)
				NW	Metric		
	NVBV-M207-10	MVBV-M207-10	M20 x 1.5	17	20	10.0	51.0 x 73.0
	NVBV-M207-6	MVBV-M207-6	M20 x 1.5	17	20	6.0	47.0 x 73.0
	NVBV-M257-11	MVBV-M257-11	M25 x 1.5	17	20	11.0	52.0 x 76.0
	NVBV-M257-7	MVBV-M257-7	M25 x 1.5	17	20	7.0	48.0 x 76.0
	NVBV-M253-11	MVBV-M253-11	M25 x 1.5	23	25	11.0	62.5 x 85.0
	NVBV-M253-7	MVBV-M253-7	M25 x 1.5	23	25	7.0	58.5 x 85.0
	NVBV-M323-13	MVBV-M323-13	M32 x 1.5	23	25	13.0	64.5 x 89.0
	NVBV-M323-8	MVBV-M323-8	M32 x 1.5	23	25	8.0	59.5 x 89.0
	NVBV-M329-13	MVBV-M329-13	M32 x 1.5	29	32	13.0	74.0 x 94.5
	NVBV-M329-8	MVBV-M329-8	M32 x 1.5	29	32	8.0	69.0 x 94.5
	NVBV-M409-13	MVBV-M409-13	M40 x 1.5	29	32	13.0	75.5 x 100.5
	NVBV-M409-8	MVBV-M409-8	M40 x 1.5	29	32	8.0	70.5 x 100.5
	NVBV-M406-13	MVBV-M406-13	M40 x 1.5	36	40	13.0	86.5 x 123.0
	NVBV-M406-8	MVBV-M406-8	M40 x 1.5	36	40	8.0	81.5 x 123.0
	NVBV-M506-14	MVBV-M506-14	M50 x 1.5	36	40	14.0	87.5 x 130.0
	NVBV-M506-9	MVBV-M506-9	M50 x 1.5	36	40	9.0	82.5 x 130.0
	NVBV-M508-14	MVBV-M508-14	M50 x 1.5	48	50	14.0	100.5 x 135.0
	NVBV-M508-9	MVBV-M508-9	M50 x 1.5	48	50	9.0	95.5 x 135.0
	NVBV-M638-10	MVBV-M638-10	M63 x 1.5	48	50	14.0	100.5 x 138.0
NVBV-M638-14	MVBV-M638-14	M63 x 1.5	48	50	10.0	96.5 x 138.0	

Approvals



For applications in railway vehicles and heavy machine construction

High thread and system connection strength

Smooth elbow allows easy threading of wires and cables

Note: Appropriate standard elbows of type VW are available for smaller conduit sizes NW 10 to NW 12

⑤ IP68GT available. Please add "GT" prior to the thread length (e.g. NVAV-M120GT-10, NVBV-M120GT-10)

Connectors metric, metal thread

Type VWV

Type VWV - Connector 90° elbow, metric metal thread

	Order no. IP68, black ^④	Order no. IP68, grey ^④	Thread metric	Fits to conduit size		Thread length (mm)	External dimensions (mm)
				NW	Metric		
	NVWV-M120-10	MVWV-M120-10	M12 x 1.5	10	12	10.0	37.5 x 39.5
	NVWV-M120-5	MVWV-M120-5	M12 x 1.5	10	12	5.0	32.5 x 39.5
	NVWV-M160-10	MVWV-M160-10	M16 x 1.5	10	12	10.0	37.5 x 41.5
	NVWV-M160-5	MVWV-M160-5	M16 x 1.5	10	12	5.0	32.5 x 41.5
	NVWV-M162-10	MVWV-M162-10	M16 x 1.5	12	16	10.0	42.0 x 46.5
	NVWV-M162-5	MVWV-M162-5	M16 x 1.5	12	16	5.0	37.0 x 46.5
	NVWV-M202-10	MVWV-M202-10	M20 x 1.5	12	16	10.0	42.0 x 49.0
	NVWV-M202-6	MVWV-M202-6	M20 x 1.5	12	16	6.0	38.0 x 49.0
	NVWV-M207-10	MVWV-M207-10	M20 x 1.5	17	20	10.0	47.0 x 58.5
	NVWV-M207-6	MVWV-M207-6	M20 x 1.5	17	20	6.0	43.0 x 58.5
	NVWV-M253-11	MVWV-M253-11	M25 x 1.5	23	25	11.0	59.0 x 67.0
	NVWV-M253-7	MVWV-M253-7	M25 x 1.5	23	25	7.0	55.0 x 67.0
	NVWV-M329-13	MVWV-M329-13	M32 x 1.5	29	32	13.0	68.0 x 74.5
	NVWV-M329-8	MVWV-M329-8	M32 x 1.5	29	32	8.0	63.0 x 74.5
	NVWV-M406-13	MVWV-M406-13	M40 x 1.5	36	40	13.0	80.5 x 98.0
	NVWV-M406-8	MVWV-M406-8	M40 x 1.5	36	40	8.0	75.5 x 98.0
	NVWV-M508-14	MVWV-M508-14	M50 x 1.5	48	50	14.0	95.5 x 111.0
	NVWV-M508-9	MVWV-M508-9	M50 x 1.5	48	50	9.0	90.5 x 111.0
	NVWV-M638-14	MVWV-M638-14	M63 x 1.5	48	50	14.0	94.5 x 114.0
NVWV-M638-10	MVWV-M638-10	M63 x 1.5	48	50	10.0	90.5 x 114.0	

Approvals



For applications in railway vehicles and heavy machine construction

High thread and system connection strength

Note: Curved elbows of type VB are also available for sizes NW 17 to NW 48

^④ IP68GT available. Please add
"GT" prior to the thread length
(e.g. NVWV-M120GT-10)

Connectors with strain relief, metric, metal thread

Type VWZ

Type VWZ - Connector 90° elbow with strain relief, metric metal thread



	Order no. IP68 Compl., black ⑤	Order no. fitting* ⑤	Order no. insert	Thread metric	Fits to conduit size		Terminal range (mm)	Thread length (mm)	Overall length (mm)
					NW	Metric			
	NVWZ-M160S/P1	NVWZ-M160R/P	E 150 p7	M16 x 1.5	10	12	4.0–6.5	8.0	65.0
	NVWZ-M160S/P2	–	E 150 p8	M16 x 1.5	10	12	5.0–8.0	8.0	65.0
	NVWZ-M160S/P3	–	E 150 p9	M16 x 1.5	10	12	6.5–9.5	8.0	65.0
	NVWZ-M202S/P1	NVWZ-M202R/P	E 127 p7	M20 x 1.5	12	16	4.0–6.5	8.0	74.5
	NVWZ-M202S/P3	–	E 152 p9	M20 x 1.5	12	16	6.5–9.5	8.0	74.5
	NVWZ-M202S/P4	–	E 152 p11	M20 x 1.5	12	16	7.0–10.5	8.0	74.5
	NVWZ-M207S/P1	NVWZ-M207R/P	E 152 p7	M20 x 1.5	17	20	4.0–6.5	8.0	81.0
	NVWZ-M207S/P3	–	E 152 p9	M20 x 1.5	17	20	6.5–9.5	8.0	81.0
	NVWZ-M207S/P4	–	E 152 p11	M20 x 1.5	17	20	7.0–10.5	8.0	81.0
	NVWZ-M207S/P5	–	E 152 p13	M20 x 1.5	17	20	9.0–13.0	8.0	81.0
	NVWZ-M257S/P5	NVWZ-M257R/P	E 153 p13	M25 x 1.5	17	20	9.0–13.0	8.0	84.0
	NVWZ-M257S/P6	–	E 153 p16	M25 x 1.5	17	20	11.5–15.5	8.0	84.0

*without insert

For applications in railway vehicles and heavy machine construction

For the separation of damp and dry areas

Straight connector: Specially formulated polyamide 6

90° elbow: Zinc diecast

Female thread and locknut: Nickel-plated brass

Pflitsch sealing insert: TPE-V

With integrated strain relief and optimal ingress protection at the cable (up to IP68/10 bar)

High thread and system connection strength

Temperature range sealing insert Pflitsch: –40°C to +135°C

⑤ IP68GT available. Please
replace “S” or “R” with “GT”
(e.g. NVWZ-M160GT/P1)

Connectors PG, polyamide thread

Type VN

Type VN - Connector straight, PG thread

	Order no. IP66 ①	Order no. IP68 ① ②	Thread PG	Fits to conduit size		Thread length (mm)	External dimensions (mm)
				NW	Metric		
	BVND-P07MGT-11	BVNV-P07M	07	07	10	11.0	34.5
	BVND-P07MGT-8	-	07	07	10	8.0	31.5
	BVND-P070GT-11	BVNV-P070	07	10	12	11.0	36.5
	BVND-P070GT-8	-	07	10	12	8.0	33.5
	BVND-P072GT-11	BVNV-P072	07	12	16	11.0	39.0
	BVND-P072GT-8	-	07	12	16	8.0	36.0
	BVND-P09MGT-11	BVNV-P09M	09	07	10	11.0	34.5
	BVND-P09MGT-8	-	09	07	10	8.0	31.5
	BVND-P090GT-11	BVNV-P090	09	10	12	11.0	36.5
	BVND-P090GT-8	-	09	10	12	8.0	33.5
	BVND-P092GT-11	BVNV-P092	09	12	16	11.0	39.0
	BVND-P092GT-8	-	09	12	16	8.0	36.0
	BVND-P097GT-11	BVNV-P097	09	17	20	11.0	47.5
	BVND-P097GT-8	-	09	17	20	8.0	44.5
	BVND-P11MGT-11	BVNV-P11M	11	07	10	11.0	34.5
	BVND-P11MGT-8	-	11	07	10	8.0	31.5
	BVND-P110GT-11	BVNV-P110	11	10	12	11.0	36.5
	BVND-P110GT-8	-	11	10	12	8.0	33.5
	BVND-P112GT-11	BVNV-P112	11	12	16	11.0	39.0
	BVND-P112GT-8	-	11	12	16	8.0	36.0
	BVND-P117GT-11	BVNV-P117	11	17	20	11.0	47.5
	BVND-P117GT-8	-	11	17	20	8.0	44.5
	BVND-P13MGT-11	BVNV-P13M	13.5	07	10	11.0	34.5
	BVND-P13MGT-8	-	13.5	07	10	8.0	31.5
	BVND-P130GT-11	BVNV-P130	13.5	10	12	11.0	36.5
	BVND-P130GT-8	-	13.5	10	12	8.0	33.5
	BVND-P132GT-11	BVNV-P132	13.5	12	16	11.0	39.0
	BVND-P132GT-8	-	13.5	12	16	8.0	36.0
	BVND-P137GT-11	BVNV-P137	13.5	17	20	11.0	47.5
	BVND-P137GT-8	-	13.5	17	20	8.0	44.5
	BVND-P160GT-11	-	16	10	12	11.0	36.5
	BVND-P160GT-8	-	16	10	12	8.0	33.5
	BVND-P162GT-11	BVNV-P162	16	12	16	11.0	39.0
	BVND-P163GT-11	BVNV-P163	16	23	25	11.0	51.0
	BVND-P163GT-8	-	16	23	25	8.0	48.0
	BVND-P167GT-11	BVNV-P167	16	17	20	11.0	47.5
	BVND-P167GT-8	-	16	17	20	8.0	44.5
	BVND-P213GT	BVNV-P213	21	23	25	12.0	52.0
	BVND-P296GT	BVNV-P296	29	36	40	12.0	67.5
	BVND-P299GT	BVNV-P299	29	29	32	12.0	53.0
BVND-P366GT	BVNV-P366	36	36	40	13.0	66.0	
BVND-P368GT	BVNV-P368	36	48	50	13.0	68.5	
BVND-P428GT	BVNV-P428	42	48	50	13.0	68.5	
BVND-P488GT	BVNV-P488	48	48	50	13.0	66.5	

Approvals



① Please replace "B" for black with "S" for grey in front of the order no.

② IP68GT available. Please add "GT" after the order no.

For cable protection systems in a wide range of applications

Connectors PG, polyamide thread

Type VNDZ/VNZ & VA

Type VNDZ/VNZ - Connector straight with strain relief, PG thread

	Order no. IP66 ①	Order no. IP68 ① ③	Thread PG	Fits to conduit size		Terminal range	Thread length (mm)	Overall length (mm)
				NW	Metric			
	BVNDZ-P090GT	BVNZ-P090S	09	10	12	4.0–8.0	7.5	56.0
	BVNDZ-P112GT	BVNZ-P112S	11	12	16	5.0–10.0	8.0	60.5
	BVNDZ-P132GT	BVNZ-P132S	13.5	12	16	6.0–12.0	9.0	62.0
	BVNDZ-P137GT	BVNZ-P137S	13.5	17	20	6.0–12.0	9.0	69.0
	BVNDZ-P167GT	BVNZ-P167S	16	17	20	10.0–14.0	10.0	72.0
	BVNDZ-P163GT	BVNZ-P163S	16	23	25	10.0–14.0	10.0	79.0
	BVNDZ-P213GT	BVNZ-P213S	21	23	25	13.0–18.0	11.0	82.0
	BVNDZ-P299GT	BVNZ-P299S	29	29	32	18.0–25.0	11.0	85.0
	BVNDZ-P366GT	BVNZ-P366S	36	36	40	22.0–32.0	13.0	112.0
	BVNDZ-P488GT	BVNZ-P488S	48	48	50	34.0–44.0	14.0	112.0

For machine and plant construction

For separation of damp and dry areas

Integrated strain relief optimally holds and seals cables

If several conductors are used with the connector multiple sealing inserts should be considered

Note: For several conductors multiple sealing inserts MDE are available

Type VA - Connector 45° elbow, PG thread

	Order no. IP66 ①	Order no. IP68 ① ②	Thread PG	Fits to conduit size		Thread length (mm)	Overall length (mm)
				NW	Metric		
	BVAD-P090GT	BVAV-P090	09	10	12	11.0	43.5 x 37.0
	BVAD-P112GT	BVAV-P112	11	12	16	11.0	48.0 x 40.0
	BVAD-P132GT	BVAV-P132	13.5	12	16	11.0	48.0 x 41.5
	BVAD-P137GT	BVAV-P137	13.5	17	20	11.0	55.5 x 51.5
	BVAD-P167GT	BVAV-P167	16	17	20	11.0	55.5 x 51.5
	BVAD-P213GT	BVAV-P213	21	23	25	11.0	63.0 x 58.0
	BVAD-P299GT	BVAV-P299	29	29	32	12.0	69.0 x 66.0
	BVAD-P366GT	BVAV-P366	36	36	40	13.0	86.0 x 86.0
	BVAD-P488GT	BVAV-P488	48	48	50	13.0	94.0 x 100.0

Approvals



For cable protection systems in a wide range of applications

① Please replace "B" for black with "S" for grey in front of the order no.

② IP68GT available. Please add "GT" after the order no.

③ IP68GT available. Please replace "S" at the end with "GT" (e.g. BVNZ-P167GT).

Connectors PG, polyamide thread

Type VB

Type VB - Connector 90° curved elbow, PG thread

	Order no. IP68 ①	Order no. IP68 ① ②	Thread PG	Fits to conduit size		Thread length (mm)	External dimensions (mm)
				NW	Metric		
	BVBD-P167GT	BVBV-P167	16	17	20	11.0	47.5 x 73.0
	BVBD-P213GT	BVBV-P213	21	23	25	12.0	57.5 x 85.0
	BVBD-P299GT	BVBV-P299	29	29	32	12.0	67.5 x 96.0
	BVBD-P366GT	BVBV-P366	36	36	40	13.0	79.0 x 123.0
	BVBD-P488GT	BVBV-P488	48	48	50	13.0	92.5 x 135.0

Approvals



For cable protection systems in a wide range of applications

Smooth elbow allows easy threading of wires and cables

Note: For smaller conduit sizes NW 07 to NW 12 appropriate standard elbows of type VW are also available

① Please replace "B" for black with "S" for grey in front of the order no.

② IP68GT available. Please add "GT" after the order no.

Connectors PG, polyamide thread

Type VW

Type VW - Connector 90° elbow, PG thread

	Order no. IP66 ①	Order no. IP68 ① ②	Thread PG	Fits to conduit size		Thread length (mm)	External dimensions (mm)
				NW	Metric		
	BVWD-P07MGT-11	BVWV-P07M	07	07	10	11.0	32.0 x 35.0
	BVWD-P07MGT-8	-	07	07	10	8.0	29.0 x 35.0
	BVWD-P070GT-11	BVWV-P070	07	10	12	11.0	34.0 x 39.5
	BVWD-P070GT-8	-	07	10	12	8.0	31.0 x 39.5
	BVWD-P072GT-11	BVWV-P072	07	12	16	11.0	38.5 x 44.5
	BVWD-P072GT-8	-	07	12	16	8.0	35.5 x 44.5
	BVWD-P09MGT-11	BVWV-P09M	09	07	10	11.0	32.0 x 36.5
	BVWD-P09MGT-8	-	09	07	10	8.0	29.0 x 36.5
	BVWD-P090GT-11	BVWV-P090	09	10	12	11.0	34.0 x 39.5
	BVWD-P090GT-8	-	09	10	12	8.0	31.0 x 39.5
	BVWD-P092GT-11	BVWV-P092	09	12	16	11.0	38.5 x 44.5
	BVWD-P092GT-8	-	09	12	16	8.0	35.5 x 44.5
	BVWD-P11MGT-11	BVWV-P11M	11	07	10	11.0	32.0 x 38.0
	BVWD-P11MGT-8	-	11	07	10	8.0	29.0 x 38.0
	BVWD-P110GT-11	BVWV-P110	11	10	12	11.0	34.0 x 41.0
	BVWD-P110GT-8	-	11	10	12	8.0	31.0 x 41.0
	BVWD-P112GT-11	BVWV-P112	11	12	16	11.0	38.5 x 46.0
	BVWD-P112GT-8	-	11	12	16	8.0	35.5 x 46.0
	BVWD-P13MGT-11	BVWV-P13M	13.5	07	10	11.0	32.0 x 39.5
	BVWD-P13MGT-8	-	13.5	07	10	8.0	29.0 x 39.5
	BVWD-P130GT-11	BVWV-P130	13.5	10	12	11.0	34.0 x 42.5
	BVWD-P130GT-8	-	13.5	10	12	8.0	31.0 x 42.5
	BVWD-P132GT-11	BVWV-P132	13.5	12	16	11.0	38.5 x 47.5
	BVWD-P132GT-8	-	13.5	12	16	8.0	35.5 x 47.5
	BVWD-P137GT-11	BVWV-P137	13.5	17	20	11.0	43.5 x 58.5
	BVWD-P137GT-8	-	13.5	17	20	8.0	40.5 x 58.5
	BVWD-P167GT-11	BVWV-P167	16	17	20	11.0	43.5 x 58.5
	BVWD-P167GT-8	-	16	17	20	8.0	40.5 x 58.5
	BVWD-P213GT	BVWV-P213	21	23	25	12.0	54.0 x 67.0
	BVWD-P299GT	BVWV-P299	29	29	32	12.0	61.5 x 74.5
	BVWD-P366GT	BVWV-P366	36	36	40	13.0	72.0 x 98.0
	BVWD-P488GT	BVWV-P488	48	48	50	13.0	85.5 x 111.0

Approvals



For cable protection systems in a wide range of applications

Note: For sizes NW 17 to NW 48 curved elbows of type VB are also available

- ① Please replace "B" for black with "S" for grey in front of the order no.
- ② IP68GT available. Please add "GT" after the order no.

Connectors PG, metal thread

Type VNV

Type VNV - Connector straight, PG metal thread

	Order no. IP68, black ②	Order no. IP68, grey ②	Thread PG	Fits to conduit size		Thread length (mm)	Overall length (mm)
				NW	Metric		
	NVNV-P090	MVNV-P090	09	10	12	12.0	42.0
	NVNV-P112	MVNV-P112	11	12	16	12.0	45.0
	NVNV-P137	MVNV-P137	13.5	17	20	13.0	54.0
	NVNV-P167	MVNV-P167	16	17	20	13.0	54.0
	NVNV-P213	MVNV-P213	21	23	25	14.0	57.0
	NVNV-P293	MVNV-P293	29	23	25	14.0	57.0
	NVNV-P299	MVNV-P299	29	29	32	14.0	58.5
	NVNV-P366	MVNV-P366	36	36	40	17.0	75.5
	NVNV-P488	MVNV-P488	48	48	50	17.0	75.5

Approvals



For applications in railway vehicles and heavy machine construction
High thread and system connection strength

② IP68GT available. Please add
"GT" after the order no.

Connectors PG, with strain relief, metal thread

Type VNZ

Type VNZ - Connector straight with strain relief, PG metal thread



	Order no. IP68 Compl., black ⑤	Order no. fitting* ⑤	Order no. insert	Thread PG	Fits to conduit size		Terminal range (mm)	Thread length (mm)	Overall length (mm)
					NW	Metric			
	NVNZ-P090S/P1	NVNZ-P090R/P	E 150 p7	09	10	12	4.0–6.5	6.0	49.5
	NVNZ-P090S/P3	–	E 150 p9	09	10	12	6.5–9.5	6.0	49.5
	NVNZ-P110S/P1	NVNZ-P110R/P	E 151 p7	11	10	12	4.0–6.5	6.0	52.0
	NVNZ-P110S/P3	–	E 151 p9	11	10	12	6.5–9.5	6.0	52.0
	NVNZ-P112S/P1	NVNZ-P112R/P	E 151 p7	11	12	16	4.0–6.5	6.0	53.5
	NVNZ-P112S/P3	–	E 151 p9	11	12	16	6.5–9.5	6.0	53.5
	NVNZ-P112S/P4	–	E 151 p11	11	12	16	7.0–10.5	6.0	53.5
	NVNZ-P160S/P1	NVNZ-P160R/P	E 152 p11	16	10	12	4.0–6.5	6.5	52.5
	NVNZ-P167S/P3	NVNZ-P167R/P	E 153 p9	16	17	20	6.5–9.5	6.5	61.0
	NVNZ-P167S/P4	–	E 153 p11	16	17	20	7.0–10.5	6.5	61.0
	NVNZ-P167S/P5	–	E 153 p13	16	17	20	9.0–13.0	6.5	61.0
	NVNZ-P167S/P6	–	E 153 p16	16	17	20	11.5–15.5	6.5	61.0
	NVNZ-P213S/P1	NVNZ-P213R/P	E 154 p11	21	23	25	7.0–10.5	7.0	72.0
	NVNZ-P213S/P4	–	E 154 p18	21	23	25	14.0–18.0	7.0	72.0
	NVNZ-P213S/P5	NVNZ-P213R1/P	E 154 p20	21	23	25	17.0–20.5	7.0	72.0
	NVNZ-P299S/P3	NVNZ-P299R/P	E 155 p20	29	29	32	17.0–20.5	8.0	73.5
	NVNZ-P299S/P4	–	E 155 p25	29	29	32	20.0–25.0	8.0	73.5
	NVNZ-P299S/P5	–	E 155 p28	29	29	32	24.0–28.0	8.0	73.5
	NVNZ-P366S/P1	NVNZ-P366R/P	E 156 p32	36	36	40	27.0–32.0	9.0	88.0
	NVNZ-P366S/P2	–	E 156 p34	36	36	40	29.0–34.0	9.0	88.0
NVNZ-P366S/P3	–	E 156 p36	36	36	40	32.0–36.0	9.0	88.0	
NVNZ-P488S/P1	NVNZ-P488R/P	E 158 pm 1x35	48	48	50	32.0–35.0	10.0	90.5	
NVNZ-P488S/P2	–	E 158 p44	48	48	50	39.0–44.0	10.0	90.5	

*without insert

For applications in railway vehicles and heavy machine construction

For the separation of damp and dry areas

Sealing inserts are made from TPE-V

With integrated strain relief and optimal ingress protection at the cable (up to IP68/10 bar)

High thread and system connection strength

Temperature range sealing insert Pflitsch: –40°C to +135°C

Note: For several conductors multiple sealing inserts MDE are available

R/P version of fitting has to be used in combination with multiple sealing inserts

Connectors PG, metal thread

Type VAV & VBV

Type VAV - Connector 45° elbow, PG metal thread

	Order no. IP68, black ②	Order no. IP68, grey ②	Thread PG	Fits to conduit size		Thread length (mm)	External dimensions (mm)
				NW	Metric		
	NVAV-P090	MVAV-P090	09	10	12	12.0	50.5 x 37.0
	NVAV-P112	MVAV-P112	11	12	16	12.0	55.0 x 40.5
	NVAV-P137	MVAV-P137	13.5	17	20	13.0	63.5 x 50.0
	NVAV-P167	MVAV-P167	16	17	20	13.0	63.5 x 50.0
	NVAV-P213	MVAV-P213	21	23	25	14.0	73.0 x 60.5
	NVAV-P299	MVAV-P299	29	29	32	14.0	78.0 x 68.0
	NVAV-P366	MVAV-P366	36	36	40	17.0	98.0 x 87.5
	NVAV-P488	MVAV-P488	48	48	50	17.0	105.0 x 101.0

Approvals



For applications in railway vehicles and heavy machine construction
High thread and system connection strength

Type VBV - Connector 90° curved elbow, PG metal thread

	Order no. IP68, black ②	Order no. IP68, grey ②	Thread PG	Fits to conduit size		Thread length (mm)	External dimensions (mm)
				NW	Metric		
	NVBV-P167	MVBV-P167	16	17	20	13.0	54.0 x 73.0
	NVBV-P213	MVBV-P213	21	23	25	14.0	65.5 x 85.0
	NVBV-P299	MVBV-P299	29	29	32	14.0	75.0 x 96.0
	NVBV-P366	MVBV-P366	36	36	40	17.0	90.5 x 123.0
	NVBV-P488	MVBV-P488	48	48	50	17.0	103.5 x 135.0

Approvals



For applications in railway vehicles and heavy machine construction
High thread and system connection strength

Smooth elbow allows easy threading of wires and cables

Note: For smaller conduit sizes NW 10 to NW 12 appropriate standard elbows of type VW are also available

② IP68GT available. Please add
"GT" after the order no.

Connectors PG, metal thread

Type VWV

Type VWV - Connector 90° elbow, PG metal thread

	Order no. IP68, black ②	Order no. IP68, grey ②	Thread PG	Fits to conduit size		Thread length (mm)	External dimensions (mm)
				NW	Metric		
	NVWV-P090	MVWV-P090	09	10	12	12.0	39.5 x 39.5
	NVWV-P112	MVWV-P112	11	12	16	12.0	45.5 x 45.0
	NVWV-P137	MVWV-P137	13.5	17	20	13.0	50.0 x 58.5
	NVWV-P167	MVWV-P167	16	17	20	13.0	50.0 x 58.5
	NVWV-P213	MVWV-P213	21	23	25	14.0	62.0 x 67.0
	NVWV-P299	MVWV-P299	29	29	32	14.0	69.0 x 74.5
	NVWV-P366	MVWV-P366	36	36	40	17.0	83.5 x 98.0
	NVWV-P488	MVWV-P488	48	48	50	17.0	96.5 x 111.0

Approvals



For applications in railway vehicles and heavy machine construction

High thread and system connection strength

Note: Curved elbows of type VB are also available for sizes NW 17 to NW 48

② IP68GT available. Please add
"GT" after the order no.

Connectors GAS, polyamide thread

Type VN & VA

Type VN - Connector straight, GAS thread

	Order no. IP66 ①	Order no. IP68 ① ②	Thread GAS	Fits to conduit size		Thread length (mm)	Overall length (mm)
				NW	Metric		
	BVND-G00MGT	BVNV-G00M	¼"	07	10	11.0	34.5
	BVND-G000GT	BVNV-G000	¼"	10	12	11.0	36.5
	BVND-G010GT	BVNV-G010	⅜"	10	12	11.0	36.5
	BVND-G012GT	BVNV-G012	⅜"	12	16	11.0	39.0
	BVND-G022GT	BVNV-G022	½"	12	16	13.0	41.0
	BVND-G027GT	BVNV-G027	½"	17	20	13.0	49.5
	BVND-G043GT	BVNV-G043	¾"	23	25	14.0	54.0
	BVND-G069GT	BVNV-G069	1"	29	32	15.0	56.0
	BVND-G076GT	BVNV-G076	1¼"	36	40	18.0	71.0
	BVND-G088GT	BVNV-G088	1½"	48	50	18.0	71.5
	BVND-G098GT	BVNV-G098	2"	48	50	18.0	71.5

For cable protection systems in a wide range of applications

Type VA - Connector 45° elbow, GAS thread

	Order no. IP66 ①	Order no. IP68 ① ②	Thread GAS	Fits to conduit size		Thread length (mm)	Overall length (mm)
				NW	Metric		
	BVAD-G000GT	BVAV-G000	¼"	10	12	11.0	43.5 x 37.0
	BVAD-G012GT	BVAV-G012	⅜"	12	16	11.0	48.0 x 40.0
	BVAD-G027GT	BVAV-G027	½"	17	20	13.0	57.5 x 51.5
	BVAD-G043GT	BVAV-G043	¾"	23	25	14.0	67.0 x 60.0
	BVAD-G069GT	BVAV-G069	1"	29	32	15.0	73.5 x 67.0
	BVAD-G076GT	BVAV-G076	1¼"	36	40	18.0	91.5 x 85.5
	BVAD-G088GT	–	1½"	48	50	18.0	99.0 x 96.0
	BVAD-G098GT	BVAV-G098	2"	48	50	18.0	99.0 x 101.0

For cable protection systems in a wide range of applications

① Please replace "B" for black with "S" for grey in front of the order no.

② IP68GT available. Please add "GT" after the order no.

Connectors GAS, polyamide thread

Type VW

Type VW - Connector 90° elbow, GAS thread

	Order no.	Order no.	Thread GAS	Fits to conduit size		Thread length (mm)	External dimensions (mm)
	IP66 ^①	IP68 ^{① ②}		NW	Metric		
	BVWD-G00MGT	BVWV-G00M	¼"	07	10	11.0	32.0 x 36.5
	BVWD-G000GT	BVWV-G000	¼"	10	12	11.0	34.0 x 39.5
	BVWD-G010GT	BVWV-G010	⅜"	10	12	11.0	34.0 x 40.5
	BVWD-G012GT	BVWV-G012	⅜"	12	16	11.0	38.5 x 46.0
	BVWD-G022GT	BVWV-G022	½"	12	16	13.0	40.5 x 47.5
	BVWD-G027GT	BVWV-G027	½"	17	20	13.0	45.5 x 58.5
	BVWD-G043GT	BVWV-G043	¾"	23	25	14.0	56.0 x 66.5
	BVWD-G069GT	BVWV-G069	1"	29	32	15.0	64.5 x 73.5
	BVWD-G076GT	BVWV-G076	1¼"	36	40	18.0	77.0 x 96.0
	BVWD-G088GT	BVWV-G088	1½"	48	50	18.0	90.5 x 106.0
	BVWD-G098GT	BVWV-G098	2"	48	50	18.0	90.5 x 111.0

For cable protection systems in a wide range of applications

^① Please replace "B" for black with "S" for grey in front of the order no.

^② IP68GT available. Please add "GT" after the order no.

Connectors NPT, polyamide thread

Type VN & VA

Type VN - Connector straight, NPT thread

	Order no. IP66 ①	Order no. IP68 ① ②	Thread NPT	Fits to conduit size		Thread length (mm)	Overall length (mm)
				NW	Metric		
	BVND-N022GT	BVNV-N022	½"	12	16	13.0	41.5
	BVND-N027GT	BVNV-N027	½"	17	20	13.0	49.5
	BVND-N043GT	BVNV-N043	¾"	23	25	14.0	54.0
	BVND-N069GT	BVNV-N069	1"	29	32	15.0	56.0
	BVND-N076GT	BVNV-N076	1¼"	36	40	18.0	71.0
	BVND-N088GT	BVNV-N088	1½"	48	50	18.0	71.5
	BVND-N098GT	BVNV-N098	2"	48	50	18.0	71.5

Approvals



For cable protection systems in a wide range of applications

Type VA - Connector 45° elbow, NPT thread

	Order no. IP68 ①	Order no. IP68 ① ②	Thread NPT	Fits to conduit size		Thread length (mm)	External dimensions (mm)
				NW	Metric		
	BVAD-N022GT	BVAV-N022	½"	12	16	13.0	50.0 x 41.5
	BVAD-N027GT	BVAV-N027	½"	17	20	13.0	57.5 x 51.5
	BVAD-N043GT	BVAV-N043	¾"	23	25	14.0	67.0 x 60.0
	BVAD-N069GT	BVAV-N069	1"	29	32	15.0	73.5 x 67.0
	BVAD-N076GT	BVAV-N076	1¼"	36	40	18.0	91.5 x 85.5
	BVAD-N088GT	BVAV-N088	1½"	48	50	18.0	99.0 x 96.0
	BVAD-N098GT	BVAV-N098	2"	48	50	18.0	99.0 x 101.0

Approvals



For cable protection systems in a wide range of applications

- ① Please replace "B" for black with "S" for grey in front of the order no.
- ② IP68GT available. Please add "GT" after the order no.

Connectors NPT, polyamide thread

Type VW

Type VW - Connector 90° elbow, NPT thread

	Order no. IP68 ①	Order no. IP68 ① ②	Thread NPT	Fits to conduit size		Thread length (mm)	External dimensions (mm)
				NW	Metric		
	BVWD-N022GT	BVWV-N022	½"	12	16	13.0	40.5 x 47.5
	BVWD-N027GT	BVWV-N027	½"	17	20	13.0	45.5 x 58.5
	BVWD-N043GT	BVWV-N043	¾"	23	25	14.0	56.0 x 66.5
	BVWD-N069GT	BVWV-N069	1"	29	32	15.0	64.5 x 73.5
	BVWD-N076GT	BVWV-N076	1¼"	36	40	18.0	77.0 x 96.0
	BVWD-N088GT	BVWV-N088	1½"	48	50	18.0	90.5 x 106.0
	BVWD-N098GT	BVWV-N098	2"	48	50	18.0	90.5 x 111.0

Approvals



For applications in railway vehicles and heavy machine construction

High thread and system connection strength

Note: Curved elbows of type VB are also available for sizes NW 17 to NW 48

① Please replace "B" for black with "S" for grey in front of the order no.

② IP68GT available. Please add "GT" after the order no.

Swivel connectors, metric/PG/NPT metal thread

Type SBV & SWV/SBV

Type SBV - Swivel connector 90° curved elbow, metric/PG metal thread

	Order no. IP68, black ⁴	Thread metric	Fits to conduit size		Thread length (mm)	External dimensions (mm)
			NW	Metric		
	NSBV-M207-10	M20 x 1.5	17	20	10.0	62.5 x 74.5
	NSBV-M253-11	M25 x 1.5	23	25	11.0	73.0 x 87.5
	NSBV-M329-13	M32 x 1.5	29	32	13.0	86.5 x 98.0
	NSBV-M406-13	M40 x 1.5	36	40	13.0	98.5 x 127.5
	NSBV-M409-13	M40 x 1.5	29	32	13.0	86.5 x 98.0
	NSBV-M508-14	M50 x 1.5	48	50	14.0	113.5 x 139.0
	NSBV-M638-14	M63 x 1.5	48	50	14.0	110.0 x 139.0

Approvals	Order no. IP68, black ⁴	Thread PG	Fits to conduit size		Thread length (mm)	External dimensions (mm)
			NW	Metric		
	NSBV-P167-6.5	16	17	20	6.5	58.0 x 74.5
	NSBV-P213-7	21	23	25	7.0	69.0 x 87.5
	NSBV-P299-8	29	29	32	8.0	80.0 x 98.0
	NSBV-P366-9	36	36	40	9.0	91.5 x 127.5
	NSBV-P488-10	48	48	50	10.0	106.0 x 139.0

For applications with high technical requirements mainly in machine building
 Suitable for occasional rotation
 Thread and integrated swivel adapter made from nickel-plated brass
 High thread and system connection strength
 Smooth elbow allows easy threading of wires and cables

Type SWV/SBV - Swivel connector 90° curved elbow, NPT metal thread

	Order no. IP68, black ⁴	Thread NPT	Fits to conduit size		Thread length (mm)	External dimensions (mm)
			NW	Metric		
	NSWV-N022/01	½"	12	16	15.4	57.0 x 48.5
	NSBV-N027/01	½"	17	20	15.4	66.5 x 74.5
	NSBV-N043/01	¾"	23	25	15.7	77.5 x 87.5
	NSBV-N069/01	1"	29	32	19.6	92.0 x 98.0
	NSBV-N076/01	1¼"	36	40	20.2	104.5 x 125.5
	NSBV-N088/01	1½"	48	50	20.6	118.5 x 138.5
	NSBV-N098/01	2"	48	50	21.4	119.5 x 138.5

Approvals



For applications with high technical requirements mainly in heavy machine building and rail applications
 Suitable for occasional rotation
 Thread and integrated swivel adapter made from colourless anodized aluminium
 High thread and system connection strength
 Smooth elbow allows easy threading of wires and cables

⁴ IP68GT available. Please add "GT" prior to the thread length (for example NSBV-M329GT-13)

Swivel connectors, metric/NPT metal thread

Type SNV

Type SNV - Swivel connector, straight, IP68 metric metal thread

	Order no. IP68, black ⁴	Thread metric	Fits to conduit size		Thread length (mm)	Overall length (mm)
			NW	Metric		
	NSNV-M120-10	M12 x 1.5	10	12	10.0	50.5
	NSNV-M162-10	M16 x 1.5	12	16	10.0	53.5
	NSNV-M207-10	M20 x 1.5	17	20	10.0	62.5
	NSNV-M253-11	M25 x 1.5	23	25	11.0	67.5
	NSNV-M329-13	M32 x 1.5	29	32	13.0	72.0
	NSNV-M329-7	M32 x 1.5	29	32	7.0	66.0
	NSNV-M406-13	M40 x 1.5	36	40	13.0	85.5
	NSNV-M406-7	M40 x 1.5	36	40	7.0	79.5
	NSNV-M409-13	M40 x 1.5	29	32	13.0	72.0
	NSNV-M508-14	M50 x 1.5	48	50	14.0	87.5
NSNV-M638-14	M63 x 1.5	48	50	14.0	84.0	

Approvals



For applications in railway vehicles and heavy machine construction
 Specially formulated polyamide 6
 Thread and integrated swivel adapter made from nickel-plated brass
 Very high impact resistance. High thread and system connection strength. Suitable for occasional rotation
 Easy introduction of wires and cables
 Vibration-proof connection to PMAFLEX conduits
 Very good chemical properties
 Free from halogens and cadmium
 Fits both conduit profiles – fine (T) and coarse (G)
 IP68, IP69

Type SNV - Swivel connector, straight, NPT metal thread

	Order no. IP68, black ⁴	Thread NPT	Fits to conduit size		Thread length (mm)	Overall length (mm)
			NW	Metric		
	NSNV-N022/01	½"	12	16	15.4	58.0
	NSNV-N027/01	½"	17	20	15.4	66.5
	NSNV-N043/01	¾"	23	25	15.7	72.0
	NSNV-N069/01	1"	29	32	19.6	77.5
	NSNV-N076/01	1¼"	36	40	20.2	91.5
	NSNV-N088/01	1½"	48	50	20.6	92.0
	NSNV-N098/01	2"	48	50	21.4	93.0

Approvals



For applications with high technical requirements mainly in machine building
 Specially formulated polyamide 6
 Thread and integrated swivel adapter made from colourless anodized aluminium
 Very high impact resistance. High thread and system connection strength. Suitable for occasional rotation
 Easy introduction of wires and cables
 Vibration-proof connection to PMAFLEX conduits
 Very good chemical properties
 Free from halogens and cadmium
 Fits both conduit profiles – fine (T) and coarse (G)
 IP68, IP69

⁴ IP68GT available. Please add "GT" prior to the thread length (for example NSBV-M329GT-13)

Swivel connectors with female NPT metal thread

Type SNIV & SBIV

Type SNIV - Swivel connector straight, female NPT metal thread, IP68

	Order no. black ⁴	Thread metric	Fits to conduit size		Thread length (mm)	Overall length (mm)
			NW	Metric		
	NSNIV-N022/01	½"	12	16	13.6	59.0
	NSNIV-N027/01	½"	17	20	13.6	67.0
	NSNIV-N043/01	¾"	23	25	14.1	72.5
	NSNIV-N069/01	1"	29	32	16.8	76.5
	NSNIV-N076/01	1¼"	36	40	17.3	91.5
	NSNIV-N088/01	1½"	48	50	17.3	93.5
	NSNIV-N098/01	2"	48	50	17.8	93.0

Approvals



For applications with high technical requirements mainly in machine building

Type SBIV - 360° Swivel connector, 90° curved elbow, IP68, female NPT metal thread

	Order no. IP68, black ⁴	Thread NPT	Fits to conduit size		Thread length (mm)	Overall length (mm)
			NW	Metric		
	NSWIV-N022/01	½"	12	16	13.6	48.5 x 46.5
	NSBIV-N027/01	½"	17	20	13.6	67.0 x 74.5
	NSBIV-N043/01	¾"	23	25	14.1	78.0 x 87.5
	NSBIV-N069/01	1"	29	32	16.8	91.0 x 98.0
	NSBIV-N076/01	1¼"	36	40	17.3	104.5 x 125.5
	NSBIV-N088/01	1½"	48	50	17.3	119.5 x 138.5
	NSBIV-N098/01	2"	48	50	17.8	119.0 x 138.5

Approvals



Technical requirements mainly in heavy machine building and rail applications
 Suitable for occasional rotation
 Specially formulated polyamide 6
 Thread and integrated swivel adapter made from colourless anodized aluminium
 Very high impact resistance
 High thread and system connection strength
 Suitable for occasional rotation
 Easy introduction of wires and cables
 Vibration-proof connection to PMAFLEX conduits
 Very good chemical properties
 Free from halogens and cadmium
 Fits both conduit profiles – fine (T) and coarse (G)
 IP68, IP69

⁴ IP68GT available. Please add "GT" prior to the thread length (for example NSBV-M329GT-13)

Flanges, connectors with female, metric thread

Type VO & VI

Type VO - Flange 90°

	Order no. IP66 ①	Order no. IP68 ① ②	Fits to conduit size		Width x Length x Depth (mm)	Screw sizes
			NW	Metric		
	BVOD-P167GT	BVOV-P167	17	20	46.0 x 66.0 x 35.5	2 x M5
	BVOD-P213GT	BVOV-P213	23	25	65.5 x 70.0 x 43.0	2 x M6
	BVOD-P299GT	BVOV-P299	29	32	67.0 x 78.0 x 49.5	4 x M6
	BVOD-P366GT	BVOV-P366	36	40	85.0 x 102.0 x 65.5	4 x M6
	BVOD-P488GT	BVOV-P488	48	50	86.0 x 119.0 x 77.5	4 x M6

For cable protection systems in a wide range of applications
 Flange seal FGO4 made from EPDM, flange seal FGO4/01 made from NBR
 Temperature range with FGO4: -40°C to +105°C
 Temperature range with FGO4/01: -25°C to +70°C

Type VI - Connector straight, female metric thread

	Order no. IP66, black	Order no. IP68, black ②	Thread metric	Fits to conduit size		Thread length (mm)	Overall length (mm)
				NW	Metric		
	BVID-M12MGT	–	M12 x 1.5	07	10	8.0	32.0
	BVID-M160GT	BVIR-M160	M16 x 1.5	10	12	8.0	33.5
	BVID-M162GT	BVIR-M162	M16 x 1.5	12	16	8.0	36.5
	–	BVIR-M202	M20 x 1.5	12	16	8.0	36.5
	BVID-M207GT	BVIR-M207	M20 x 1.5	17	20	8.0	44.5
	BVID-M253GT	BVIR-M253	M25 x 1.5	23	25	8.0	48.5
	–	BVIR-M257	M25 x 1.5	17	20	8.0	44.5
	BVID-M329GT	BVIR-M329	M32 x 1.5	29	32	10.0	51.5
	BVID-M406GT	BVIR-M406	M40 x 1.5	36	40	10.0	65.5
	BVID-M508GT	BVIR-M508	M50 x 1.5	48	50	10.0	65.5
	BVID-M638GT	BVIR-M638	M63 x 1.5	48	50	10.0	65.5

For cable protection systems in a wide range of applications
 VID: IP66 static/IP54 dynamic, conduit side
 VIR: IP68 static/IP67 dynamic, conduit side
 No seal on female thread side

Approvals



① Please replace "B" for black with "S" for grey in front of the order no.

② IP68GT available. Please add "GT" after the order no.

Connectors with female, metric metal thread

Type VIR

Type VIR - Connector straight, female metric metal thread

	Order no. IP68, black ②	Thread metric	Fits to conduit size		Thread length (mm)	Overall length (mm)
			NW	Metric		
	NVIR-M120	M12 x 1.5	10	12	7.5	35.0
	NVIR-M160	M16 x 1.5	10	12	9.0	40.5
	NVIR-M162	M16 x 1.5	12	16	9.0	42.0
	NVIR-M207	M20 x 1.5	17	20	10.0	50.0
	NVIR-M253	M25 x 1.5	23	25	10.0	56.0
	NVIR-M329	M32 x 1.5	29	32	11.0	55.5
	NVIR-M406	M40 x 1.5	36	40	13.0	71.0
	NVIR-M508	M50 x 1.5	48	50	15.0	75.0
	NVIR-M638	M63 x 1.5	48	50	17.5	76.0

Approvals



For applications in railway vehicles and heavy machine construction
 High thread and system connection strengths
 VIR: IP68 static/IP67 dynamic, conduit side
 No seal on female thread side

- ① Please replace "B" for black with "S" for grey in front of the order no.
- ② IP68GT available. Please add "GT" after the order no.

Connector straight, PG female thread

Type FIL/VIR & VIZR

Type FIL/VIR - Connector straight, female PG thread

	Order no. IP67, black	Order no. IP68, black ②	Thread PG	Fits to conduit size		Thread length (mm)	Overall length (mm)
				NW	Metric		
	BFIL-P07M	–	07	07	10	8.0	29.0
	BFIL-P070	–	07	10	12	8.0	34.5
	–	BVIR-P070	07	10	12	8.0	33.5
	BFIL-P090	–	09	10	12	8.0	32.5
	–	BVIR-P090	09	10	12	8.0	33.5
	BFIL-P112	–	11	12	16	8.0	32.5
	–	BVIR-P112	11	12	16	8.0	36.5
	BFIL-P117	–	11	17	20	8.0	35.0
	BFIL-P132	–	13.5	12	16	8.0	32.5
	BFIL-P137	–	13.5	17	20	8.0	33.5
	BFIL-P160	–	16	10	12	7.0	37.0
	BFIL-P167	–	16	17	20	8.0	33.5
	–	BVIR-P167	16	17	20	8.0	44.5
	BFIL-P217	–	21	17	20	10.5	35.5
	BFIL-P213	–	21	23	25	8.0	39.0
	BFIL-P293	–	29	23	25	9.0	42.0
	BFIL-P299	–	29	29	32	9.0	43.0
	BFIL-P363	–	36	23	25	12.0	51.0
	BFIL-P369	–	36	29	32	16.0	52.0
	BFIL-P366	–	36	36	25	13.0	64.0
BFIL-P488	–	48	48	50	13.0	65.0	

For cable protection systems in a wide range of applications

VIR: IP68 static/IP67 dynamic, conduit side

FIL: IP67 static/IP65 dynamic, conduit side

No seal on female thread side

Type VIZR - Connector straight, female PG metal thread

	Order no. IP68, black ②	Thread PG	Fits to conduit size		Thread length (mm)	Overall length (mm)
			NW	Metric		
	NVIZR-P07M	07	07	10	6.0	35.0
	NVIZR-P090	09	10	12	9.0	38.5
	NVIZR-P110	11	10	12	9.0	41.0
	NVIZR-P112	11	12	16	9.0	42.0
	NVIZR-P137	13.5	17	20	8.0	46.5
	NVIZR-P167	16	17	20	9.5	48.0
	NVIZR-P213	21	23	25	10.0	58.0
	NVIZR-P299	29	29	32	12.5	57.0
	NVIZR-P366	36	36	40	13.0	76.0
	NVIZR-P488	48	48	50	14.0	75.0

For applications in railway vehicles and heavy machine construction

High thread and system connection strengths

VIZR: IP68 static/IP67 dynamic, conduit side

No seal on female thread side

② IP68GT available. Please add
"GT" after the order no.

Connectors with female UNEF thread

Type VI

Type VI - Connector straight, UNEF female thread for AMP connectors

	Order no. IP66, black	Order no. IP68, black ^②	Thread UNEF	Fits to conduit size		Thread length (mm)	Overall length (mm)
				NW	Metric		
	BVIDA-U15MGT	BVIRA-U15M	5/8"-24	07	10	8.0	31.5
	BVIDA-U150GT	BVIRA-U150	5/8"-24	10	12	8.0	33.5
	BVIDA-U152GT	BVIRA-U152	5/8"-24	12	16	8.0	36.5
	BVIDA-U180GT	BVIRA-U180	3/4"-20	10	12	8.0	33.5
	BVIDA-U182GT	BVIRA-U182	3/4"-20	12	16	8.0	36.5
	BVIDA-U187GT	BVIRA-U187	3/4"-20	17	20	8.0	44.5
	BVIDA-U232GT	BVIRA-U232	1 5/16"-20	12	16	8.0	38.5
	BVIDA-U237GT	BVIRA-U237	1 5/16"-20	17	20	8.0	46.5
	BVIDA-U233GT	BVIRA-U233	1 5/16"-20	23	25	8.0	48.5
	BVIDA-U347GT	BVIRA-U347	1 3/8"-18	17	20	8.0	46.5
	BVIDA-U343GT	BVIRA-U343	1 3/8"-18	23	25	8.0	48.5
	BVIDA-U402GT	BVIRA-U402	1 5/8"-18	12	16	7.0	55.5
	BVIDA-U407GT	BVIRA-U407	1 5/8"-18	17	20	7.0	61.5
	BVIDA-U403GT	BVIRA-U403	1 5/8"-18	23	25	7.0	60.5

For cable protection systems in a wide range of applications

Suitable for the AMP connector serie CPC

VIDA: IP66 static/IP54 dynamic, conduit side. VIRA: IP68 static/IP67 dynamic, conduit side

No seal on female thread side

Type VI - Connector straight, UNEF female thread for Souriau connectors

	Order no. IP66, black	Order no. IP68, black ^②	Thread UNEF	Fits to NW	Shell size UTG-6	Thread length (mm)	Overall length (mm)
BVIDB-U202GT	BVIRB-U202	1 3/16"-20	12	14-12	4.5	44.0	
BVIDB-U232GT	BVIRB-U232	1 5/16"-20	12	16-19	4.5	49.0	
BVIDB-U237GT	BVIRB-U237	1 5/16"-20	17	16-19	4.5	52.0	
BVIDB-U267GT	BVIRB-U267	1 1/16"-18	17	18-23	4.5	52.0	
BVIDB-U297GT	BVIRB-U297	1 3/16"-18	17	20-28	6.5	55.5	
BVIDB-U293GT	BVIRB-U293	1 3/16"-18	23	20-28	6.5	52.0	
BVIDB-U323GT	BVIRB-U323	1 5/16"-18	23	22-35	6.5	52.0	
BVIDB-U357GT	BVIRB-U357	1 7/16"-18	17	24-48	6.5	58.5	
BVIDB-U353GT	BVIRB-U353	1 7/16"-18	23	24-48	6.5	54.0	
BVIDB-U359GT	BVIRB-U359	1 7/16"-18	29	24-48	6.5	50.5	

For cable protection systems in a wide range of applications

Suitable for the Souriau connector series UTG-6/ITT Cannon Trident

VIDB: IP66 static/IP54 dynamic, conduit side. VIRB: IP68 static/IP67 dynamic, conduit side

No seal on female thread side

	Order no. IP68, black ^②	Thread UNEF	Fits to NW	Shell size UTG-6	Thread length (mm)	Overall length (mm)
	BVIRS-U162	1 1/16"-24	12	12	9.4	47.5
	BVIRS-U202	1 3/16"-20	12	14	9.4	47.5
	BVIRS-U237	1 5/16"-20	17	16	10.0	56.0
	BVIRS-U267	1 1/16"-18	17	18	9.2	55.5
	BVIRS-U293	1 3/16"-18	23	20	9.8	56.0
	BVIRS-U323	1 5/16"-18	23	22	9.8	56.0
	BVIRS-U359	1 7/16"-18	29	24	9.7	55.5

For cable protection systems in a wide range of applications

Suitable for the Souriau connector series UTO and UTS

VIRS: IP68 static/IP67 dynamic, conduit side. No seal on female thread side

^② IP68GT available. Please add "GT" after the order no.

Connectors with female UN thread

Type VI

Type VI - Connector straight, UN female thread for MIL-C5015

	Order no. IP66, black	Order no. IP68, black ②	Thread UN	Fits to conduit size		Thread length (mm)	Overall length (mm)
				NW	Metric		
	-	BVIVG-U152*	5/8" -24 UNEF	12	16	8.0	36.5
	-	BVIVG-U187*	3/4" -20 UNEF	17	20	9.0	46.5
	-	BVIVG-U210*	7/8" -20 UNEF	10	07	9.0	37.0
	BVIDG-U212GT	BVIVG-U212*	7/8" -20 UNEF	12	16	9.0	38.5
	BVIDG-U217GT	BVIVG-U217*	7/8" -20 UNEF	17	20	9.0	46.5
	BVIDG-U242GT	BVIVG-U242*	1" -20 UNEF	12	16	9.0	40.5
	-	BVIVG-U243*	1" -20 UNEF	23	25	9.0	55.0
	BVIDG-U247GT	BVIVG-U247*	1" -20 UNEF	17	20	9.0	47.5
	-	BVIVG-U292*	1 3/16" -18 UNEF	12	16	9.0	40.5
	BVIDG-U293GT	BVIVG-U293*	1 3/16" -18 UNEF	23	25	9.0	55.0
	BVIDG-U297GT	BVIVG-U297*	1 3/16" -18 UNEF	17	20	9.0	47.5
	-	BVIVG-U299*	1 3/16" -18 UNEF	29	32	9.0	47.0
	-	BVIVG-U349*	1 3/8" -18 UNEF	29	32	9.0	52.0
	-	BVIVG-U352*	1 7/16" -18 UNEF	12	16	9.0	39.0
	BVIDG-U353GT	BVIVG-U353*	1 7/16" -18 UNEF	23	25	9.0	52.0
	-	BVIVG-U356*	1 7/16" -18 UNEF	36	40	9.0	63.0
	BVIDG-U357GT	BVIVG-U357*	1 7/16" -18 UNEF	17	20	9.0	46.5
	BVIDG-U359GT	BVIVG-U359*	1 7/16" -18 UNEF	29	29	9.0	52.0
	BVIDG-U433GT	BVIVG-U433*	1 3/4" -18 UNS	23	25	10.0	52.0
	BVIDG-U436GT	BVIVG-U436*	1 3/4" -18 UNS	36	40	10.0	62.5
	-	BVIVG-U437*	1 3/4" -18 UNS	17	20	10.0	46.5
	BVIDG-U439GT	BVIVG-U439*	1 3/4" -18 UNS	29	32	10.0	51.5
	-	BVIVG-U503*	2" -18 UNS	23	25	10.0	51.5
	BVIDG-U506GT	BVIVG-U506*	2" -18 UNS	36	40	10.0	62.5
	-	BVIVG-U508*	2" -18 UNS	48	50	10.0	64.5
	BVIDG-U509GT	BVIVG-U509*	2" -18 UNS	29	32	10.0	55.0
	-	BVIVG-U563*	2 1/4" -16 UN	23	25	10.0	51.0
	BVIDG-U566GT	BVIVG-U566*	2 1/4" -16 UN	36	40	10.0	62.0
-	BVIVG-U568*	2 1/4" -16 UN	48	50	10.0	64.0	
BVIDG-U569GT	BVIVG-U569*	2 1/4" -16 UN	29	32	10.0	51.0	
-	BVIVG-U628*	2 1/2" -16 UN	48	50	10.0	64.0	

Approvals



For applications in machine, vehicle and traction building industries
Suitable for MIL connector series C5015

VIDG: IP66 static/IP54 dynamic, conduit- and thread side

VIVG: IP68 static/IP67 dynamic, conduit- and thread side

No seal on female thread side

* UL Recognition according to UL 1619

Y, T pieces, conduit adapters

Type VY & VT

Type VY - Y piece

	Order no. IP66 ①	Order no. IP68 ① ②	1 x conduit size		2 x conduit size	
			NW	Metric	NW	Metric
	BVYD-100707GT	BVYR-100707	10	12	07	10
	BVYD-121010GT	BVYR-121010	12	16	10	12
	BVYD-171212GT	BVYR-171212	17	20	12	16
	BVYD-231717GT	BVYR-231717	23	25	17	20
	BVYD-292323GT	BVYR-292323	29	32	23	25
	BVYD-362929GT	BVYR-362929	36	40	29	32
	BVYD-483636GT	BVYR-483636	48	50	36	40

Approvals



Sizes can be adapted with AV conduit adapters to fit smaller conduit dimensions

Type VT - T piece

	Order no. IP66 ①	Order no. IP68 ① ②	3 x conduit size	
			NW	Metric
	BVTD-101010GT	BVTR-101010	10	12
	BVTD-121212GT	BVTR-121212	12	16
	BVTD-171717GT	BVTR-171717	17	20
	BVTD-232323GT	BVTR-232323	23	25
	BVTD-292929GT	BVTR-292929	29	32
	BVTD-363636GT	BVTR-363636	36	40
	BVTD-484848GT	BVTR-484848	48	50

Approvals



Sizes can be adapted with AV conduit adapters to fit smaller conduit dimensions

- ① Please replace "B" for black with "S" for grey in front of the order no.
- ② IP68GT available. Please add "GT" after the order no.

Y, T pieces, conduit adapters

Type AV

Type AV - Conduit adapter

	Order no. IP66, black	Order no. IP68, black	Fits to fitting for		Fits to fitting size		Overall length (mm)
			NW	Metric	NW	Metric	
AV	–	BAVR-10/07	10	12	07	10	43.0
	BAVD-12/10GT	BAVR-12/10	12	16	10	12	46.0
	BAVD-17/10GT	BAVR-17/10	17	20	10	12	53.0
	BAVD-17/12GT	BAVR-17/12	17	20	12	16	54.0
	BAVD-23/10GT	BAVR-23/10	23	25	10	12	54.0
	BAVD-23/12GT	BAVR-23/12	23	25	12	16	53.0
	BAVD-23/17GT	BAVR-23/17	23	25	17	20	62.0
	BAVD-29/10GT	BAVR-29/10	29	32	10	12	56.5
	BAVD-29/12GT	BAVR-29/12	29	32	12	16	55.0
	BAVD-29/17GT	BAVR-29/17	29	32	17	20	61.0
	BAVD-29/23GT	BAVR-29/23	29	32	23	25	64.0
	BAVD-36/29GT	BAVR-36/29	36	40	29	32	81.0
	BAVD-48/36GT	BAVR-48/36	48	50	36	40	88.5

Approvals



Allows conduit size reduction of PMA connectors, particularly of T and Y pieces

